



DZ18TC

COOLING CAPACITY: 23,000 - 56,500 BTU/H
HEATING CAPACITY: 22,600 - 59,500 BTU/H

**HIGH-EFFICIENCY,
COMMUNICATING,
SPLIT SYSTEM HEAT PUMP
UP TO 19 SEER & 10 HSPF**



■ Contents

Nomenclature.....	2
Product Specifications.....	3
Expanded Cooling Data.....	4
Expanded Heating Data.....	20
AHRI Ratings (see note).....	22
Dimensions.....	27
Wiring Diagram.....	28
Accessories.....	29

■ Standard Features

- Two-Stage Copeland® UltraTech scroll compressor
- High-density foam compressor sound blanket
- Compatible with Daikin *One+* smart thermostat and other Daikin communicating equipment
- Advanced Copeland CoreSense™ Technology
- Efficient, two-speed ECM condenser fan motor
- Simple low-voltage wiring to outdoor unit in communicating mode
- Diagnostic indicator lights and storage of six fault codes
- Color-coded terminal strip for non-communicating set-up
- High- and low-pressure switches
- Time-delay technology with short-cycle protection to ensure quiet, reliable defrost
- Factory-installed bi-flow liquid-line filter drier
- Factory-installed suction-line accumulator
- Factory-installed compressor crankcase heater
- Factory-installed high-capacity muffler
- Factory-installed coil and ambient temperature sensors
- AHRI Certified; ETL Listed

■ Cabinet Features

- Grille-style sound control top design
- Custom Nickel Gray powder-paint finish
- 500-hour salt-spray tested
- Wire fan discharge grille
- Steel louver coil guard
- Single panel access to controls with space provided for field-installed accessories
- Sweat connection service valves with easy access to gauge ports
- When properly anchored, meets the 2017 Florida Building Code unit integrity requirements for hurricane-type winds (Anchor bracket kits available.)







Proper sizing and installation of equipment is critical to achieve optimal performance. Split system air conditioners and heat pumps must be matched with appropriate coil components to meet ENERGY STAR® criteria. Ask your contractor for details or visit www.energystar.gov.



* Complete warranty details available from your local dealer or at www.daikincomfort.com. To receive the 12-Year Unit Replacement Limited Warranty and 12-Year Parts Limited Warranty, online registration must be completed within 60 days of installation. Additional requirements for annual maintenance are required for the Unit Replacement Limited Warranty. Online registration and some of the additional requirements are not required in California or Quebec.

	D	Z	18	T	C	036	3	*	*	
	1	2	3,4	5	6	7,8,9	10	11	12	
Brand	D - Daikin									Engineering *
										Major & Minor revisions
										* Not used for inventory purposes
Type	X - AC R-410A									Voltage
	Z - HP R-410A									1 - 208/230 V Single-Phase 60 Hz
SEER	14 - 14 SEER		18 - 18 SEER							Nominal Tonnage
	16 - 16 SEER		20 - 20 SEER					024 - 2 tons	048 - 4 tons	
								036 - 3 tons	060 - 5 tons	
Compressor	S - Single Stage		V - Variable Speed							Feature Set
	T - Two Stage							A - Base	D - Deluxe	
								C - Communicating	N - Nominal	

	DZ18TC 0241C*	DZ18TC 0361C*	DZ18TC 0481C*	DZ18TC 0601C*
CAPACITIES AND RATINGS				
Nominal Cooling (BTU/h)	23,800	34,800	49,500	56,500
Nominal Heating (BTU/h)	23,000	35,000	51,000	59,500
Decibels	68	72	75	75
COMPRESSOR				
RLA	10.0	14.8	20.4	22.9
LRA	62.9	84.22	122.1	147.2
CONDENSER FAN MOTOR				
Horsepower	1/3	1/3	1/3	1/3
FLA	2.8	2.8	2.8	2.8
REFRIGERATION SYSTEM				
Refrigerant Line Size				
Liquid Line Size ("O.D.)	3/8"	3/8"	3/8"	3/8"
Suction Line Size ("O.D.)	7/8"	7/8"	1 1/8"	1 1/8"
Refrigerant Connection Size				
Liquid Valve Size ("O.D.)	3/8"	3/8"	3/8"	3/8"
Suction Valve Size ("O.D.)	7/8"	7/8"	1 1/8"	1 1/8"
Valve Connection Type	Sweat	Sweat	Sweat	Sweat
Refrigerant Charge (oz.)	187	219	308	288
Expansion Device	TXV	TXV	TXV	TXV
Superheat at Service Valve	7-9°F	7-9°F	7-9°F	7-9°F
Subcooling at Service Valve				
High Stage	8-10°F	8-10°F	8-10°F	8-10°F
Low Stage	5-7°F	5-7°F	5-7°F	5-7°F
ELECTRICAL DATA				
Volts-Phase (60 Hz)	208/230-1-60	208/230-1-60	208/230-1-60	208/230-1-60
Minimum Circuit Ampacity ²	15.3	21.3	28.3	31.4
Max. Overcurrent Protection ³	25	35	45	50
Min / Max Volts	197 / 253	197 / 253	197 / 253	197 / 253
Electrical Conduit Size	1/2" or 3/4"	1/2" or 3/4"	1/2" or 3/4"	1/2" or 3/4"
EQUIPMENT WEIGHT (LBS)				
	230	260	316	319
SHIP WEIGHT (LBS)				
	250	280	336	339
ENERGY STAR® CERTIFIED [^]				
				

¹ Tested and rated in accordance with AHRI Standard 210/240

² Wire size should be determined in accordance with National Electrical Codes; extensive wire runs will require larger wire sizes

³ Must use time-delay fuses or HACR-type circuit breakers of the same size as noted.

NOTES

- Always check the rating plate for electrical data on the unit being installed.
- Installer will need to supply 3/8" to 1 1/8" adapters for suction line connections.
- Unit is charged with refrigerant for 15' of 3/8" liquid line. System charge must be adjusted per Installation Instructions Final Charge Procedure.
- Installation of these units requires the specified TXV Kit to be installed on the indoor coil.
THE SPECIFIED TXV IS DETERMINED BY THE OUTDOOR UNIT, NOT THE INDOOR COIL.

[^] ENERGY STAR NOTES

- Products that are recognized as the Most Efficient of ENERGY STAR® in 2020 prevent greenhouse gas emissions by meeting rigorous energy efficiency performance levels set by the U.S. Environmental Protection Agency.
- Proper sizing and installation of equipment is critical to achieve optimal performance. Split system air conditioners and heat pumps must be matched with appropriate coil components to meet ENERGY STAR® criteria. Ask your contractor for details or visit www.energystar.gov.
- The www.energystar.gov website provides up-to-date system combinations certified to meet ENERGY STAR requirements. See Page 22 for all ENERGY STAR-certified combinations as of this document's revision date.
- [†]The ENERGY STAR® Most Efficient 2021 recognition applies only to systems with the Daikin One+ smart thermostat

DESIGN SUBCOOLING 5 - 7 °F @ THE LIQUID SERVICE VALVE, ARI 95 TEST CONDITIONS

IDB		OUTDOOR AMBIENT TEMPERATURE												ENTERING INDOOR WET BULB TEMPERATURE											
		65°F				75°F				85°F				95°F				105°F				115°F			
		59	63	67	71	59	63	67	71	59	63	67	71	59	63	67	71	59	63	67	71	59	63	67	71
70	MBh	24.1	24.4	25.2	-	23.9	24.2	24.9	-	23.2	23.6	24.3	-	22.2	22.5	23.2	-	20.8	21.2	21.9	-	19.6	19.9	20.7	-
	S/T	0.61	0.53	0.38	-	0.61	0.53	0.39	-	0.64	0.56	0.41	-	1.00	0.58	0.44	-	1.00	0.60	0.46	-	1.00	0.66	0.51	-
	ΔT	38	34	28	-	38	34	28	-	37	34	28	-	37	34	27	-	37	34	27	-	39	36	29	-
	kW	1.17	1.17	1.16	-	1.31	1.31	1.31	-	1.47	1.47	1.47	-	1.64	1.64	1.64	-	1.83	1.83	1.83	-	2.06	2.06	2.06	-
	Amps	4.8	4.8	4.8	-	5.5	5.5	5.5	-	6.2	6.2	6.2	-	7.0	7.0	7.0	-	7.9	7.9	7.9	-	8.9	8.9	8.9	-
Hi PR	238	239	241	-	276	277	278	-	315	316	318	-	358	359	360	-	403	404	406	-	452	453	455	-	
Lo PR	126	128	131	-	134	136	139	-	141	143	146	-	147	148	152	-	152	154	157	-	159	161	164	-	
800	MBh	24.4	24.7	25.4	-	24.1	24.5	25.2	-	23.5	23.9	24.6	-	22.4	22.8	23.5	-	21.1	21.4	22.2	-	19.9	20.2	20.9	-
	S/T	0.68	0.60	0.46	-	0.69	0.61	0.46	-	0.71	0.63	0.49	-	1.00	0.65	0.51	-	1.00	0.68	0.53	-	1.00	0.73	0.59	-
	ΔT	35	32	26	-	35	32	26	-	36	32	26	-	35	32	26	-	35	32	25	-	37	34	27	-
	kW	1.17	1.17	1.17	-	1.32	1.32	1.31	-	1.48	1.48	1.47	-	1.65	1.65	1.65	-	1.84	1.84	1.84	-	2.07	2.07	2.06	-
	Amps	4.9	4.9	4.9	-	5.5	5.5	5.5	-	6.3	6.3	6.2	-	7.1	7.0	7.0	-	7.9	7.9	7.9	-	9.0	9.0	8.9	-
Hi PR	240	241	243	-	278	279	280	-	317	318	320	-	360	361	362	-	405	406	408	-	454	455	457	-	
Lo PR	128	130	133	-	136	137	141	-	143	144	147	-	148	150	153	-	154	156	159	-	161	163	166	-	
855	MBh	24.5	24.9	25.6	-	24.3	24.7	25.4	-	23.7	24.0	24.7	-	22.6	22.9	23.7	-	21.3	21.6	22.3	-	20.1	20.4	21.1	-
	S/T	0.71	0.63	0.48	-	0.72	0.64	0.49	-	1.00	0.66	0.52	-	1.00	0.68	0.54	-	1.00	0.71	0.56	-	1.00	1.00	0.62	-
	ΔT	34	31	25	-	34	31	25	-	35	31	25	-	34	31	25	-	34	31	24	-	36	33	26	-
	kW	1.18	1.18	1.17	-	1.32	1.32	1.32	-	1.48	1.48	1.48	-	1.65	1.65	1.65	-	1.84	1.84	1.84	-	2.07	2.07	2.07	-
	Amps	4.9	4.9	4.9	-	5.6	5.5	5.5	-	6.3	6.3	6.3	-	7.1	7.1	7.1	-	7.9	7.9	7.9	-	9.0	9.0	9.0	-
Hi PR	241	242	244	-	279	280	281	-	318	319	321	-	361	362	363	-	406	407	409	-	455	456	458	-	
Lo PR	129	131	134	-	137	138	142	-	144	145	148	-	149	151	154	-	155	157	160	-	162	164	167	-	

700	MBh	24.1	24.4	25.2	26.3	23.9	24.2	25.0	26.1	23.3	23.6	24.3	25.4	22.2	22.5	23.2	24.3	20.8	21.2	21.9	23.0	19.6	20.0	20.7	21.8
	S/T	0.74	0.66	0.52	0.4	1.00	0.67	0.53	0.4	1.00	0.70	0.55	0.4	1.00	0.72	0.57	0.4	1.00	0.74	0.60	0.4	1.00	1.00	0.65	0.5
	ΔT	45	42	35	29	45	42	35	29	45	42	36	29	45	42	35	29	44	41	35	28	47	43	37	30.3
	kW	1.17	1.17	1.16	1.2	1.31	1.31	1.31	1.3	1.47	1.47	1.46	1.5	1.64	1.64	1.64	1.6	1.83	1.83	1.83	1.8	2.06	2.06	2.05	2.1
	Amps	4.8	4.8	4.8	4.9	5.5	5.5	5.5	5.5	6.2	6.2	6.2	6.3	7.0	7.0	7.0	7.0	7.9	7.9	7.9	7.9	8.9	8.9	8.9	9.0
Hi PR	238	239	241	245	276	277	279	283	315	316	318	322	358	359	361	365	404	405	406	411	453	454	455	459	
Lo PR	126	128	131	137	134	136	139	144	141	143	146	151	147	148	152	157	152	154	157	163	159	161	164	170	
800	MBh	24.4	24.7	25.4	26.5	24.2	24.5	25.2	26.3	23.5	23.9	24.6	25.7	22.4	22.8	23.5	24.6	21.1	21.5	22.2	23.3	19.9	20.2	21.0	22.1
	S/T	0.82	0.74	0.59	0.4	1.00	0.74	0.60	0.4	1.00	0.77	0.63	0.5	1.00	0.79	0.65	0.5	1.00	1.00	0.67	0.5	1.00	1.00	0.73	0.6
	ΔT	43	40	33	27	43	39	33	27	43	40	34	27	43	39	33	27	42	39	33	26	44	41	35	28.2
	kW	1.17	1.17	1.17	1.2	1.32	1.32	1.31	1.3	1.48	1.47	1.47	1.5	1.65	1.65	1.64	1.7	1.84	1.84	1.84	1.8	2.07	2.06	2.06	2.1
	Amps	4.9	4.9	4.9	4.9	5.5	5.5	5.5	5.6	6.3	6.3	6.2	6.3	7.0	7.0	7.0	7.1	7.9	7.9	7.9	8.0	9.0	9.0	8.9	9.0
Hi PR	240	241	243	247	278	279	280	285	317	318	320	324	360	361	362	367	406	407	408	413	455	456	457	461	
Lo PR	128	130	133	138	136	137	141	146	143	144	148	153	148	150	153	159	154	156	159	164	161	163	166	171	
855	MBh	24.5	24.9	25.6	26.7	24.3	24.7	25.4	26.5	23.7	24.0	24.8	25.9	22.6	23.0	23.7	24.8	21.3	21.6	22.3	23.4	20.1	20.4	21.1	22.2
	S/T	0.85	0.77	0.62	0.5	1.00	0.77	0.63	0.5	1.00	0.80	0.66	0.5	1.00	0.82	0.68	0.5	1.00	1.00	0.70	0.5	1.00	1.00	0.75	0.6
	ΔT	42	39	32	26	42	38	32	26	42	39	33	26	42	38	32	26	41	38	32	25	43	40	34	27.2
	kW	1.18	1.18	1.17	1.2	1.32	1.32	1.32	1.3	1.48	1.48	1.48	1.5	1.65	1.65	1.65	1.7	1.84	1.84	1.84	1.9	2.07	2.07	2.07	2.1
	Amps	4.9	4.9	4.9	4.9	5.5	5.5	5.5	5.6	6.3	6.3	6.3	6.3	7.1	7.1	7.0	7.1	7.9	7.9	7.9	8.0	9.0	9.0	9.0	9.0
Hi PR	241	242	244	248	279	280	282	286	318	319	321	325	361	362	364	368	407	408	409	414	456	457	458	462	
Lo PR	129	131	134	139	137	138	142	147	144	145	149	154	149	151	154	160	155	157	160	165	162	164	167	172	

IDB: Entering Indoor Dry Bulb Temperature
 High and low pressures are measured at the liquid and suction service valves.
 Shaded area reflects ACCA (TVA) conditions
 kW = Total system power
 Amps = outdoor unit amps (compressor + fan)

EXPANDED COOLING DATA — DZ18TC0241C* / CA*F3137*6A*+MBVC1200** -1A*+TX (HIGH STAGE)

DESIGN SUBCOOLING 5 - 7 °F @ THE LIQUID SERVICE VALVE, ARI 95 TEST CONDITIONS

IDB		OUTDOOR AMBIENT TEMPERATURE												ENTERING INDOOR WET BULB TEMPERATURE											
		65°F				75°F				85°F				95°F				105°F				115°F			
		59	63	67	71	59	63	67	71	59	63	67	71	59	63	67	71	59	63	67	71	59	63	67	71
80	MBh	24.2	24.6	25.3	26.4	24.0	24.4	25.1	26.2	23.4	23.7	24.4	25.5	22.3	22.6	23.4	24.5	21.0	21.3	22.0	23.1	19.7	20.1	20.8	21.9
	S/T	1.00	0.80	0.65	0.5	1.00	0.80	0.66	0.5	1.00	0.83	0.69	0.5	1.00	1.00	0.71	0.6	1.00	1.00	0.73	0.6	1.00	1.00	0.79	0.6
	ΔT	53	49	43	36	52	49	43	36	53	50	43	37	52	49	43	36	52	49	40	36	54	51	44	37.8
	kW	1.17	1.17	1.16	1.2	1.31	1.31	1.31	1.3	1.47	1.47	1.47	1.5	1.64	1.64	1.64	1.6	1.83	1.83	1.83	1.8	2.06	2.06	2.06	2.1
	Amps	4.8	4.8	4.8	4.9	5.5	5.5	5.5	5.5	6.2	6.2	6.2	6.3	7.0	7.0	7.0	7.0	7.9	7.9	7.9	7.9	8.9	8.9	8.9	9.0
	Hi PR	239	240	241	245	276	277	279	283	316	317	318	323	358	359	361	365	404	405	407	411	453	454	456	460
	Lo PR	127	129	132	137	135	136	140	145	142	143	146	152	147	149	152	158	153	155	158	163	160	162	165	170
	MBh	24.5	24.8	25.6	26.7	24.3	24.6	25.3	26.5	23.7	24.0	24.7	25.8	22.6	22.9	23.6	24.7	21.2	21.6	22.3	23.4	20.0	20.4	21.1	22.2
	S/T	1.00	0.87	0.73	0.6	1.00	0.88	0.73	0.6	1.00	0.91	0.76	0.6	1.00	1.00	0.78	0.6	1.00	1.00	0.80	0.7	1.00	1.00	0.86	0.7
	ΔT	50	47	41	34	50	47	41	34	51	47	41	35	50	47	41	34	50	46	40	34	52	49	42	35.7
kW	1.17	1.17	1.17	1.2	1.32	1.32	1.32	1.3	1.48	1.48	1.47	1.5	1.65	1.65	1.64	1.7	1.84	1.84	1.84	1.8	2.07	2.07	2.06	2.1	
Amps	4.9	4.9	4.9	4.9	5.5	5.5	5.5	5.6	6.3	6.3	6.2	6.3	7.1	7.0	7.0	7.1	7.9	7.9	7.9	8.0	9.0	9.0	8.9	9.0	
Hi PR	241	242	243	247	278	279	281	285	318	319	320	325	360	361	363	367	406	407	409	413	455	456	458	462	
Lo PR	129	130	134	139	136	138	141	147	143	145	148	154	149	151	154	159	155	156	159	165	162	163	166	172	
MBh	24.7	25.0	25.7	26.8	24.5	24.8	25.5	26.6	23.8	24.2	24.9	26.0	22.7	23.1	23.8	24.9	21.4	21.7	22.5	23.6	20.2	20.5	21.3	22.4	
S/T	1.00	0.90	0.76	0.6	1.00	0.91	0.76	0.6	1.00	1.00	0.79	0.6	1.00	1.00	0.81	0.7	1.00	1.00	0.83	0.7	1.00	1.00	1.00	0.7	
ΔT	49	46	40	33	49	46	40	33	50	46	40	34	49	46	40	33	49	45	39	33	51	48	41	34.7	
kW	1.18	1.18	1.17	1.2	1.32	1.32	1.32	1.3	1.48	1.48	1.48	1.5	1.65	1.65	1.65	1.7	1.84	1.84	1.84	1.9	2.07	2.07	2.07	2.1	
Amps	4.9	4.9	4.9	4.9	5.6	5.5	5.5	5.6	6.3	6.3	6.3	6.3	7.1	7.1	7.1	7.1	7.9	7.9	7.9	8.0	9.0	9.0	9.0	9.0	
Hi PR	242	243	244	248	279	280	282	286	319	320	321	326	361	362	364	368	407	408	410	414	456	457	459	463	
Lo PR	130	131	135	140	137	139	142	148	144	146	149	154	150	152	155	160	156	157	160	166	163	164	167	173	

85	MBh	24.6	25.0	25.7	26.8	24.4	24.8	25.5	26.6	23.8	24.1	24.9	26.0	22.7	23.0	23.8	24.9	21.4	21.7	22.4	23.5	20.2	20.5	21.2	22.3
	S/T	1.00	0.91	0.76	0.6	1.00	1.00	0.77	0.6	1.00	1.00	0.79	0.6	1.00	1.00	0.81	0.7	1.00	1.00	1.00	0.7	1.00	1.00	1.00	0.7
	ΔT	59	56	49	43	59	56	49	43	60	56	50	43	59	56	49	43	59	55	49	42	61	57	51	44.5
	kW	1.17	1.17	1.17	1.2	1.31	1.31	1.31	1.3	1.47	1.47	1.47	1.5	1.64	1.64	1.64	1.7	1.84	1.83	1.83	1.8	2.06	2.06	2.06	2.1
	Amps	4.9	4.9	4.8	4.9	5.5	5.5	5.5	5.5	6.2	6.2	6.2	6.3	7.0	7.0	7.0	7.1	7.9	7.9	7.9	7.9	8.9	8.9	8.9	9.0
	Hi PR	240	241	242	247	277	278	280	284	317	318	320	324	359	360	362	366	405	406	408	412	454	455	457	461
	Lo PR	129	131	134	139	137	138	142	147	143	145	148	154	149	151	154	159	155	156	160	165	162	163	167	172
	MBh	24.9	25.3	26.0	27.1	24.7	25.0	25.8	26.9	24.1	24.4	25.1	26.2	23.0	23.3	24.0	25.1	21.6	22.0	22.7	23.8	20.4	20.8	21.5	22.6
	S/T	1.00	0.98	0.84	0.7	1.00	1.00	0.84	0.7	1.00	1.00	0.87	0.7	1.00	1.00	0.89	0.7	1.00	1.00	1.00	0.8	1.00	1.00	1.00	0.8
	ΔT	57	54	47	41	57	54	47	41	57	54	48	41	57	54	47	41	56	53	47	40	59	55	49	42.3
kW	1.18	1.18	1.17	1.2	1.32	1.32	1.32	1.3	1.48	1.48	1.48	1.5	1.65	1.65	1.65	1.7	1.84	1.84	1.84	1.9	2.07	2.07	2.07	2.1	
Amps	4.9	4.9	4.9	4.9	5.5	5.5	5.5	5.6	6.3	6.3	6.3	6.3	7.1	7.1	7.0	7.1	7.9	7.9	7.9	8.0	9.0	9.0	9.0	9.0	
Hi PR	242	243	244	249	279	280	282	286	319	320	322	326	361	362	364	368	407	408	410	414	456	457	459	463	
Lo PR	131	132	135	141	138	140	143	149	145	147	150	155	151	152	156	161	157	158	161	167	164	165	168	174	
MBh	25.1	25.4	26.1	27.2	24.9	25.2	25.9	27.0	24.2	24.6	25.3	26.4	23.1	23.5	24.2	25.3	21.8	22.2	22.9	24.0	20.6	20.9	21.7	22.8	
S/T	1.00	1.00	0.86	0.7	1.00	1.00	0.87	0.7	1.00	1.00	0.90	0.7	1.00	1.00	0.92	0.8	1.00	1.00	1.00	0.8	1.00	1.00	1.00	0.8	
ΔT	56	53	46	40	56	53	46	40	56	53	47	40	56	53	46	40	55	52	46	39	58	54	48	41.3	
kW	1.18	1.18	1.18	1.2	1.32	1.32	1.32	1.3	1.48	1.48	1.48	1.5	1.65	1.65	1.65	1.7	1.85	1.85	1.84	1.9	2.07	2.07	2.07	2.1	
Amps	4.9	4.9	4.9	4.9	5.6	5.6	5.5	5.6	6.3	6.3	6.3	6.3	7.1	7.1	7.1	7.1	8.0	8.0	7.9	8.0	9.0	9.0	9.0	9.0	
Hi PR	243	244	245	250	280	281	283	287	320	321	323	327	362	363	365	369	408	409	411	415	457	458	460	464	
Lo PR	132	133	136	142	139	141	144	150	146	148	151	156	152	153	157	162	158	159	162	168	165	166	169	175	

IDB: Entering Indoor Dry Bulb Temperature
 High and low pressures are measured at the liquid and suction service valves.
 Shaded area reflects AHRI conditions
 kW = Total system power
 Amps = outdoor unit amps (compressor + fan)

DESIGN SUBCOOLING 5 - 7 °F @ THE LIQUID SERVICE VALVE, ARI 95 TEST CONDITIONS

IDB		OUTDOOR AMBIENT TEMPERATURE												ENTERING INDOOR WET BULB TEMPERATURE											
		65°F				75°F				85°F				95°F				105°F				115°F			
		59	63	67	71	59	63	67	71	59	63	67	71	59	63	67	71	59	63	67	71	59	63	67	71
70	MBh	25.7	26.1	26.9	-	25.5	25.9	26.6	-	24.8	25.2	26.0	-	23.7	24.0	24.8	-	22.2	22.6	23.4	-	21.0	21.3	22.1	-
	S/T	0.59	0.51	0.37	-	0.60	0.52	0.38	-	0.62	0.54	0.40	-	1.00	0.56	0.42	-	1.00	0.59	0.45	-	1.00	0.64	0.50	-
	ΔT	22	20	16	-	22	20	16	-	22	20	17	-	22	20	16	-	22	20	16	-	23	21	17	-
	kW	1.24	1.24	1.23	-	1.42	1.42	1.41	-	1.62	1.61	1.61	-	1.83	1.83	1.83	-	2.07	2.07	2.07	-	2.35	2.35	2.35	-
	Amps	5.3	5.3	5.3	-	6.1	6.1	6.1	-	7.0	7.0	7.0	-	8.0	8.0	8.0	-	9.1	9.1	9.1	-	10.4	10.4	10.3	-
Hi PR	221	222	223	-	256	257	258	-	292	293	295	-	332	333	334	-	374	375	377	-	420	421	422	-	
Lo PR	126	127	130	-	133	135	138	-	140	142	145	-	146	147	151	-	151	153	156	-	158	160	163	-	
850	MBh	26.2	26.6	27.3	-	26.0	26.3	27.1	-	25.3	25.7	26.4	-	24.1	24.5	25.3	-	22.7	23.1	23.8	-	21.4	21.8	22.6	-
	S/T	0.69	0.61	0.47	-	0.69	0.61	0.47	-	0.72	0.64	0.50	-	1.00	0.66	0.52	-	1.00	0.68	0.54	-	1.00	0.73	0.60	-
	ΔT	20	18	15	-	20	18	15	-	20	18	15	-	20	18	14	-	20	18	14	-	21	19	15	-
	kW	1.25	1.25	1.25	-	1.43	1.43	1.43	-	1.63	1.63	1.62	-	1.84	1.84	1.84	-	2.08	2.08	2.08	-	2.36	2.36	2.36	-
	Amps	5.3	5.3	5.3	-	6.2	6.2	6.1	-	7.1	7.1	7.0	-	8.0	8.0	8.0	-	9.1	9.1	9.1	-	10.4	10.4	10.4	-
Hi PR	223	224	226	-	258	259	261	-	295	296	298	-	334	335	337	-	377	378	379	-	422	423	425	-	
Lo PR	128	130	133	-	136	138	141	-	143	144	147	-	148	150	153	-	154	156	159	-	161	163	166	-	
900	MBh	26.4	26.7	27.5	-	26.2	26.5	27.3	-	25.5	25.8	26.6	-	24.3	24.7	25.5	-	22.9	23.3	24.0	-	21.6	22.0	22.7	-
	S/T	0.70	0.63	0.49	-	0.71	0.63	0.49	-	1.00	0.66	0.52	-	1.00	0.68	0.54	-	1.00	0.70	0.56	-	1.00	1.00	0.61	-
	ΔT	20	18	14	-	20	18	14	-	20	18	14	-	20	18	14	-	19	17	14	-	21	19	15	-
	kW	1.26	1.26	1.25	-	1.43	1.43	1.43	-	1.63	1.63	1.63	-	1.85	1.85	1.84	-	2.09	2.09	2.08	-	2.37	2.37	2.36	-
	Amps	5.4	5.4	5.3	-	6.2	6.2	6.2	-	7.1	7.1	7.1	-	8.1	8.1	8.0	-	9.2	9.2	9.1	-	10.4	10.4	10.4	-
Hi PR	224	225	227	-	259	260	262	-	296	297	298	-	335	336	338	-	378	379	380	-	423	424	426	-	
Lo PR	129	131	134	-	137	138	142	-	144	145	148	-	149	151	154	-	155	156	160	-	162	163	167	-	

700	MBh	25.8	26.1	26.9	28.1	25.5	25.9	26.7	27.8	24.8	25.2	26.0	27.2	23.7	24.0	24.8	26.0	22.3	22.6	23.4	24.6	21.0	21.3	22.1	23.3
	S/T	0.72	0.64	0.50	0.4	1.00	0.65	0.51	0.4	1.00	0.68	0.54	0.4	1.00	0.70	0.56	0.4	1.00	0.72	0.58	0.4	1.00	1.00	0.63	0.5
	ΔT	26	24	21	17	26	24	21	17	27	25	21	17	26	24	21	17	26	24	20	17	27	25	22	17.8
	kW	1.24	1.24	1.23	1.2	1.42	1.41	1.41	1.4	1.61	1.61	1.61	1.6	1.83	1.83	1.82	1.8	2.07	2.07	2.06	2.1	2.35	2.35	2.35	2.4
	Amps	5.3	5.3	5.3	5.3	6.1	6.1	6.1	6.1	7.0	7.0	7.0	7.0	8.0	8.0	8.0	8.0	9.1	9.1	9.1	9.1	10.4	10.4	10.3	10.4
Hi PR	221	222	223	227	256	257	258	262	292	293	295	299	332	333	334	338	374	375	377	381	420	421	422	426	
Lo PR	126	127	130	136	133	135	138	144	140	142	145	150	146	147	151	156	151	153	156	162	158	160	163	169	
750	MBh	26.2	26.6	27.4	28.5	26.0	26.3	27.1	28.3	25.3	25.7	26.4	27.6	24.1	24.5	25.3	26.5	22.7	23.1	23.9	25.0	21.4	21.8	22.6	23.7
	S/T	0.82	0.74	0.60	0.5	1.00	0.75	0.61	0.5	1.00	0.77	0.63	0.5	1.00	0.79	0.65	0.5	1.00	1.00	0.68	0.5	1.00	1.00	0.73	0.6
	ΔT	25	23	19	15	25	23	19	15	25	23	19	15	25	23	19	15	24	22	19	15	26	24	20	16.0
	kW	1.25	1.25	1.25	1.3	1.43	1.43	1.43	1.4	1.63	1.63	1.62	1.6	1.84	1.84	1.84	1.9	2.08	2.08	2.08	2.1	2.36	2.36	2.36	2.4
	Amps	5.3	5.3	5.3	5.4	6.2	6.1	6.1	6.2	7.1	7.1	7.0	7.1	8.0	8.0	8.0	8.1	9.1	9.1	9.1	9.1	10.4	10.4	10.4	10.5
Hi PR	224	225	226	230	259	260	261	265	295	296	298	302	335	336	337	341	377	378	380	384	423	423	425	429	
Lo PR	128	130	133	138	136	138	141	146	143	144	148	153	148	150	153	159	154	156	159	164	161	163	166	171	
900	MBh	26.4	26.8	27.5	28.7	26.2	26.5	27.3	28.5	25.5	25.9	26.6	27.8	24.3	24.7	25.5	26.6	22.9	23.3	24.0	25.2	21.6	22.0	22.8	23.9
	S/T	0.84	0.76	0.62	0.5	1.00	0.77	0.63	0.5	1.00	0.79	0.65	0.5	1.00	0.81	0.67	0.5	1.00	1.00	0.69	0.5	1.00	1.00	0.75	0.6
	ΔT	24	22	18	15	24	22	18	15	24	22	19	15	24	22	18	15	24	22	18	14	25	23	19	15.5
	kW	1.26	1.25	1.25	1.3	1.43	1.43	1.43	1.4	1.63	1.63	1.63	1.6	1.85	1.84	1.84	1.9	2.09	2.08	2.08	2.1	2.37	2.37	2.36	2.4
	Amps	5.4	5.4	5.3	5.4	6.2	6.2	6.2	6.2	7.1	7.1	7.1	7.1	8.1	8.1	8.0	8.1	9.2	9.2	9.1	9.1	10.4	10.4	10.4	10.5
Hi PR	224	225	227	231	259	260	262	266	296	297	299	302	335	336	338	342	378	379	381	384	423	424	426	430	
Lo PR	129	131	134	139	137	138	142	147	144	145	148	154	149	151	154	160	155	157	160	165	162	164	167	172	

IDB: Entering Indoor Dry Bulb Temperature
 High and low pressures are measured at the liquid and suction service valves.
 Shaded area reflects ACCA (TVA) conditions
 kW = Total system power
 Amps = outdoor unit amps (compressor + fan)

EXPANDED COOLING DATA — DZ18TC0361C* / CA*F3743*6D*+MBVC1600** -1A*+TX (LOW STAGE)

DESIGN SUBCOOLING 5 - 7 °F @ THE LIQUID SERVICE VALVE, ARI 95 TEST CONDITIONS

IDB		OUTDOOR AMBIENT TEMPERATURE																																			
		65°F						75°F						85°F						95°F						105°F						115°F					
		59	63	67	71	75	79	59	63	67	71	75	79	59	63	67	71	75	79	59	63	67	71	75	79	59	63	67	71	75	79	59	63	67	71	75	79
AIRFLOW		ENTERING INDOOR WET BULB TEMPERATURE																																			
80	MBh	25.9	26.3	27.0	28.2	25.7	26.0	26.8	28.0	25.0	25.3	26.1	27.3	23.8	24.2	25.0	26.1	22.4	22.8	23.5	24.7	21.1	21.5	22.2	23.4	21.1	21.5	22.2	23.4	21.1	21.5	22.2	23.4	21.1	21.5	22.2	23.4
	S/T	1.00	0.77	0.63	0.5	1.00	0.78	0.64	0.5	1.00	0.80	0.67	0.5	1.00	1.00	0.69	0.5	1.00	1.00	0.71	0.6	1.00	1.00	0.76	0.6	1.00	1.00	0.76	0.6	1.00	1.00	0.76	0.6	1.00	1.00	0.76	0.6
	ΔT	31	29	25	21	31	29	25	21	31	29	25	21	31	29	25	21	30	28	25	21	32	30	26	22.1	32	30	26	22.1	32	30	26	22.1	32	30	26	22.1
	kW	1.24	1.24	1.23	1.2	1.42	1.42	1.41	1.4	1.62	1.61	1.61	1.6	1.83	1.83	1.83	1.8	2.07	2.07	2.06	2.1	2.35	2.35	2.35	2.4	2.07	2.07	2.06	2.1	2.35	2.35	2.35	2.4	2.35	2.35	2.35	2.4
	Amps	5.3	5.3	5.3	5.3	6.1	6.1	6.1	6.1	7.0	7.0	7.0	7.0	8.0	8.0	8.0	8.0	9.1	9.1	9.1	9.1	10.4	10.4	10.4	10.4	9.1	9.1	9.1	9.1	10.4	10.4	10.4	10.4	10.4	10.4	10.4	10.4
Hi PR	221	222	224	228	256	257	259	263	293	294	295	299	332	333	335	339	375	376	377	381	420	421	423	427	375	376	377	381	420	421	423	427	420	421	423	427	
Lo PR	126	128	131	136	134	136	139	144	141	142	145	151	146	148	151	157	152	154	157	162	159	161	164	169	152	154	157	162	159	161	164	169	159	161	164	169	
850	MBh	26.3	26.7	27.5	28.7	26.1	26.5	27.3	28.4	25.4	25.8	26.6	27.8	24.3	24.6	25.4	26.6	22.9	23.2	24.0	25.2	21.6	21.9	22.7	23.9	21.6	21.9	22.7	23.9	21.6	21.9	22.7	23.9	21.6	21.9	22.7	23.9
	S/T	1.00	0.87	0.73	0.6	1.00	0.88	0.74	0.6	1.00	0.90	0.76	0.6	1.00	1.00	0.78	0.6	1.00	1.00	0.80	0.7	1.00	1.00	0.86	0.7	1.00	1.00	0.86	0.7	1.00	1.00	0.86	0.7	1.00	1.00	0.86	0.7
	ΔT	29	27	23	19	29	27	23	19	29	27	24	20	29	27	23	19	29	27	23	19	30	28	24	20.4	30	28	24	20.4	30	28	24	20.4	30	28	24	20.4
	kW	1.25	1.25	1.25	1.3	1.43	1.43	1.43	1.4	1.63	1.63	1.62	1.6	1.84	1.84	1.84	1.9	2.08	2.08	2.08	2.1	2.36	2.36	2.36	2.4	2.08	2.08	2.08	2.1	2.36	2.36	2.36	2.4	2.36	2.36	2.36	2.4
	Amps	5.3	5.3	5.3	5.4	6.2	6.2	6.2	6.2	7.1	7.1	7.1	7.1	8.0	8.0	8.0	8.1	9.1	9.1	9.1	9.1	10.4	10.4	10.4	10.5	9.1	9.1	9.1	9.1	10.4	10.4	10.4	10.5	10.4	10.4	10.4	10.5
Hi PR	224	225	227	230	259	260	261	265	296	297	298	302	335	336	338	341	378	379	380	384	423	424	425	429	378	379	380	384	423	424	425	429	423	424	425	429	
Lo PR	129	130	134	139	137	138	141	147	143	145	148	153	149	151	154	159	155	156	159	165	162	163	166	172	155	156	159	165	162	163	166	172	162	163	166	172	
900	MBh	26.5	26.9	27.7	28.8	26.3	26.7	27.4	28.6	25.6	26.0	26.8	27.9	24.5	24.8	25.6	26.8	23.0	23.4	24.2	25.4	21.7	22.1	22.9	24.1	21.7	22.1	22.9	24.1	21.7	22.1	22.9	24.1	21.7	22.1	22.9	24.1
	S/T	1.00	0.89	0.75	0.6	1.00	0.89	0.76	0.6	1.00	0.90	0.78	0.6	1.00	1.00	0.80	0.7	1.00	1.00	0.82	0.7	1.00	1.00	0.86	0.7	1.00	1.00	0.86	0.7	1.00	1.00	0.86	0.7	1.00	1.00	0.86	0.7
	ΔT	28	27	23	19	28	26	23	19	29	27	23	19	28	26	23	19	28	26	22	19	29	27	24	19.9	29	27	24	19.9	29	27	24	19.9	29	27	24	19.9
	kW	1.26	1.26	1.26	1.3	1.43	1.43	1.43	1.4	1.63	1.63	1.63	1.6	1.85	1.85	1.84	1.9	2.09	2.09	2.08	2.1	2.37	2.37	2.36	2.4	2.09	2.09	2.08	2.1	2.37	2.37	2.36	2.4	2.37	2.37	2.36	2.4
	Amps	5.4	5.4	5.3	5.4	6.2	6.2	6.2	6.2	7.1	7.1	7.1	7.1	8.1	8.1	8.0	8.1	9.2	9.2	9.2	9.1	10.4	10.4	10.4	10.5	9.2	9.2	9.1	9.2	10.4	10.4	10.4	10.5	10.4	10.4	10.4	10.5
Hi PR	225	226	227	231	260	261	262	266	296	297	299	303	336	337	338	342	378	379	381	385	424	425	426	430	378	379	381	385	424	425	426	430	424	425	426	430	
Lo PR	130	131	135	140	137	139	142	148	144	146	149	154	150	151	155	160	156	157	160	166	163	164	167	173	156	157	160	166	163	164	167	173	163	164	167	173	

700	MBh	26.3	26.7	27.5	28.6	26.1	26.5	27.2	28.4	25.4	25.8	26.6	27.7	24.3	24.6	25.4	26.6	22.8	23.2	24.0	25.2	21.5	21.9	22.7	23.9	21.5	21.9	22.7	23.9	21.5	21.9	22.7	23.9	21.5	21.9	22.7	23.9
	S/T	1.00	0.88	0.74	0.6	1.00	1.00	0.74	0.6	1.00	1.00	0.77	0.6	1.00	1.00	0.79	0.6	1.00	1.00	0.80	0.7	1.00	1.00	0.86	0.7	1.00	1.00	0.86	0.7	1.00	1.00	0.86	0.7	1.00	1.00	0.86	0.7
	ΔT	35	33	29	25	35	33	29	25	35	33	29	25	35	33	29	25	34	32	29	25	36	34	30	26.0	36	34	30	26.0	36	34	30	26.0	36	34	30	26.0
	kW	1.24	1.24	1.24	1.3	1.42	1.42	1.42	1.4	1.62	1.62	1.61	1.6	1.83	1.83	1.83	1.8	2.07	2.07	2.07	2.1	2.35	2.35	2.35	2.4	2.07	2.07	2.07	2.1	2.35	2.35	2.35	2.4	2.35	2.35	2.35	2.4
	Amps	5.3	5.3	5.3	5.3	6.1	6.1	6.1	6.2	7.0	7.0	7.0	7.1	8.0	8.0	8.0	8.0	9.1	9.1	9.1	9.1	10.4	10.4	10.4	10.4	9.1	9.1	9.1	9.1	10.4	10.4	10.4	10.4	10.4	10.4	10.4	10.4
Hi PR	222	223	225	229	257	258	260	264	294	295	296	300	333	334	336	340	376	377	378	382	421	422	424	428	376	377	378	382	421	422	424	428	421	422	424	428	
Lo PR	128	130	133	138	136	137	141	146	143	144	147	153	148	150	153	158	154	155	159	164	161	162	166	171	154	155	159	164	161	162	166	171	161	162	166	171	
850	MBh	26.8	27.1	27.9	29.1	26.6	26.9	27.7	28.9	25.9	26.2	27.0	28.2	24.7	25.1	25.9	27.0	23.3	23.7	24.4	25.6	22.0	22.4	23.1	24.3	22.0	22.4	23.1	24.3	22.0	22.4	23.1	24.3	22.0	22.4	23.1	24.3
	S/T	1.00	0.97	0.83	0.7	1.00	1.00	0.84	0.7	1.00	1.00	0.87	0.7	1.00	1.00	0.89	0.7	1.00	1.00	0.80	0.8	1.00	1.00	0.86	0.7	1.00	1.00	0.86	0.7	1.00	1.00	0.86	0.7	1.00	1.00	0.86	0.7
	ΔT	33	31	27	23	33	31	27	23	33	31	27	24	33	31	27	23	33	31	27	23	34	32	28	24.3	34	32	28	24.3	34	32	28	24.3	34	32	28	24.3
	kW	1.26	1.25	1.25	1.3	1.43	1.43	1.43	1.4	1.63	1.63	1.63	1.6	1.85	1.85	1.84	1.9	2.09	2.08	2.08	2.1	2.37	2.37	2.36	2.4	2.09	2.08	2.08	2.1	2.37	2.37	2.36	2.4	2.37	2.37	2.36	2.4
	Amps	5.4	5.4	5.3	5.4	6.2	6.2	6.2	6.2	7.1	7.1	7.1	7.1	8.1	8.1	8.0	8.1	9.2	9.2	9.2	9.1	10.4	10.4	10.4	10.5	9.2	9.2	9.1	9.2	10.4	10.4	10.4	10.5	10.4	10.4	10.4	10.5
Hi PR	225	226	228	231	260	261	263	266	297	298	299	303	336	337	339	342	379	380	381	385	424	425	426	430	379	380	381	385	424	425	426	430	424	425	426	430	
Lo PR	131	132	136	141	138	140	143	149	145	147	150	155	151	152	156	161	156	158	161	167	163	165	168	174	156	158	161	167	163	165	168	174	163	165	168	174	
900	MBh	27.0	27.3	28.1	29.3	26.7	27.1	27.9	29.1	26.1	26.4	27.2	28.4	24.9	25.3	26.0	27.2	23.5	23.8	24.6	25.8	22.2	22.5	23.3	24.5	22.2	22.5	23.3	24.5	22.2	22.5	23.3	24.5	22.2	22.5	23.3	24.5
	S/T	1.00	0.99	0.85	0.7	1.00	1.00	0.86	0.7	1.00	1.00	0.89	0.7	1.00	1.00	0.91	0.8	1.00	1.00	0.80	0.8	1.00	1.00</														

EXPANDED COOLING DATA — DZ18TC0361C* / CA*F3743*6D*+MBVC1600** -1A*+TX (HIGH STAGE)

DESIGN SUBCOOLING 5 - 7 °F @ THE LIQUID SERVICE VALVE, ARI 95 TEST CONDITIONS

IDB		OUTDOOR AMBIENT TEMPERATURE																																			
		65°F						75°F						85°F						95°F						105°F						115°F					
		59	63	67	71	71	59	63	67	71	71	59	63	67	71	71	59	63	67	71	71	59	63	67	71	71	59	63	67	71	71						
AIRFLOW		59	63	67	71	71	59	63	67	71	71	59	63	67	71	71	59	63	67	71	71	59	63	67	71	71	59	63	67	71	71						
1050		MBh	35.4	35.9	36.9	36.9	-	35.0	35.5	36.6	-	34.1	34.6	35.7	-	32.5	33.0	34.1	-	30.6	31.1	32.1	-	28.8	29.3	30.4	-	28.8	29.3	30.4	-						
		S/T	0.61	0.53	0.39	0.39	-	0.62	0.54	0.40	0.40	-	0.64	0.56	0.42	-	0.66	0.58	0.44	-	1.00	0.61	0.47	-	1.00	0.66	0.52	-	1.00	0.66	0.52	-					
		ΔT	19	17	14	14	-	19	17	14	14	-	19	18	14	-	19	17	14	-	19	17	14	-	20	18	15	-	20	18	15	-					
		kW	1.77	1.76	1.76	1.76	-	1.99	1.98	1.98	1.98	-	2.23	2.23	2.23	-	2.50	2.50	2.49	-	2.80	2.79	2.79	-	3.14	3.14	3.14	-	3.14	3.14	3.14	-					
		Amps	7.0	7.0	7.0	7.0	-	8.0	8.0	8.0	8.0	-	9.2	9.2	9.1	-	10.4	10.4	10.4	-	11.7	11.7	11.7	-	13.3	13.3	13.3	-	13.3	13.3	13.3	-					
		Hi PR	229	230	232	232	-	265	266	268	268	-	303	304	306	-	344	345	347	-	388	389	391	-	435	436	438	-	435	436	438	-					
		Lo PR	120	122	125	125	-	128	129	132	132	-	134	136	139	-	139	141	144	-	145	146	149	-	151	153	156	-	151	153	156	-					
		MBh	35.9	36.4	37.4	37.4	-	35.6	36.1	37.1	37.1	-	34.6	35.1	36.2	-	33.0	33.5	34.6	-	31.1	31.6	32.7	-	29.3	29.8	30.9	-	29.3	29.8	30.9	-					
		S/T	0.68	0.60	0.46	0.46	-	0.69	0.61	0.47	0.47	-	0.71	0.63	0.49	-	0.73	0.65	0.51	-	1.00	0.68	0.54	-	1.00	0.73	0.59	-	1.00	0.73	0.59	-					
		ΔT	18	16	13	13	-	18	16	13	13	-	18	16	13	-	18	16	13	-	18	16	13	-	19	17	14	-	19	17	14	-					
		kW	1.78	1.78	1.77	1.77	-	2.00	2.00	1.99	1.99	-	2.25	2.24	2.24	-	2.51	2.51	2.51	-	2.81	2.81	2.80	-	3.16	3.16	3.15	-	3.16	3.16	3.15	-					
		Amps	7.1	7.1	7.1	7.1	-	8.1	8.1	8.1	8.1	-	9.2	9.2	9.2	-	10.4	10.4	10.4	-	11.8	11.8	11.8	-	13.4	13.4	13.4	-	13.4	13.4	13.4	-					
		Hi PR	231	232	234	234	-	268	269	270	270	-	305	306	308	-	346	347	349	-	390	391	393	-	437	438	440	-	437	438	440	-					
		Lo PR	122	124	127	127	-	130	131	134	134	-	136	138	141	-	141	143	146	-	147	148	151	-	153	155	158	-	153	155	158	-					
		MBh	36.3	36.8	37.9	37.9	-	36.0	36.5	37.6	37.6	-	35.1	35.6	36.7	-	33.5	34.0	35.1	-	31.6	32.1	33.1	-	29.8	30.3	31.3	-	29.8	30.3	31.3	-					
		S/T	0.71	0.63	0.49	0.49	-	0.72	0.64	0.50	0.50	-	0.74	0.66	0.53	-	0.76	0.68	0.55	-	1.00	0.71	0.57	-	1.00	0.76	0.62	-	1.00	0.76	0.62	-					
		ΔT	17	15	12	12	-	17	15	12	12	-	17	16	12	-	17	15	12	-	17	15	12	-	18	16	13	-	18	16	13	-					
		kW	1.79	1.79	1.78	1.78	-	2.01	2.01	2.00	2.00	-	2.25	2.25	2.25	-	2.52	2.52	2.51	-	2.82	2.82	2.81	-	3.17	3.16	3.16	-	3.17	3.16	3.16	-					
		Amps	7.1	7.1	7.1	7.1	-	8.1	8.1	8.1	8.1	-	9.3	9.3	9.2	-	10.5	10.5	10.5	-	11.8	11.8	11.8	-	13.4	13.4	13.4	-	13.4	13.4	13.4	-					
		Hi PR	233	234	236	236	-	269	270	272	272	-	307	308	310	-	348	349	351	-	392	393	395	-	439	440	442	-	439	440	442	-					
		Lo PR	124	125	128	128	-	131	133	136	136	-	138	139	142	-	143	145	148	-	148	150	153	-	155	157	160	-	155	157	160	-					

		MBh	35.4	35.9	36.9	38.6	38.6	35.1	35.6	36.6	38.2	38.2	34.1	34.6	35.7	37.3	37.3	32.5	33.0	34.1	35.7	35.7	30.6	31.1	32.2	33.8	33.8	28.8	29.3	30.4	32.0
		S/T	0.74	0.66	0.52	0.4	0.4	0.75	0.67	0.53	0.4	0.4	1.00	0.69	0.56	0.4	0.4	1.00	0.71	0.58	0.44	0.44	1.00	0.74	0.60	0.5	0.5	1.00	0.79	0.65	0.5
		ΔT	23	21	18	15	15	23	21	18	14	14	23	21	18	15	15	23	21	18	14	14	23	21	18	14	14	24	22	19	15.3
		kW	1.76	1.76	1.76	1.8	1.8	1.98	1.98	1.98	1.98	2.0	2.23	2.23	2.23	2.2	2.2	2.50	2.50	2.49	2.5	2.5	2.79	2.79	2.79	2.8	2.8	3.14	3.14	3.14	3.2
		Amps	7.0	7.0	7.0	7.1	7.1	8.0	8.0	8.0	8.1	8.1	9.2	9.1	9.1	9.2	9.2	10.4	10.4	10.4	10.4	10.4	11.7	11.7	11.7	11.8	11.8	13.3	13.3	13.4	13.4
		Hi PR	229	230	232	236	236	266	267	268	272	272	304	305	306	310	310	344	345	347	351	351	388	389	391	395	395	435	436	438	442
		Lo PR	120	122	125	130	130	128	129	132	137	137	134	136	139	144	144	140	141	144	144	149	145	146	149	155	152	153	156	161	161
		MBh	35.9	36.4	37.4	39.1	39.1	35.6	36.1	37.1	38.7	38.7	34.6	35.1	36.2	37.8	37.8	33.1	33.6	34.6	36.2	36.2	31.1	31.6	32.7	34.3	34.3	29.3	29.8	30.9	32.5
		S/T	0.81	0.73	0.59	0.4	0.4	0.82	0.74	0.60	0.5	0.5	1.00	0.76	0.63	0.5	0.5	1.00	0.78	0.65	0.5	0.5	1.00	0.81	0.67	0.5	1.00	1.00	0.72	0.6	
		ΔT	22	20	17	13	13	22	20	17	13	13	22	20	17	14	14	22	20	17	13	13	21	20	16	13	23	21	17	14.1	14.1
		kW	1.78	1.78	1.77	1.8	1.8	2.00	2.00	1.99	2.0	2.0	2.24	2.24	2.24	2.3	2.3	2.51	2.50	2.50	2.5	2.5	2.81	2.81	2.80	2.8	2.8	3.16	3.15	3.15	3.2
		Amps	7.1	7.1	7.1	7.1	7.1	8.1	8.1	8.1	8.1	9.2	9.2	9.2	9.2	9.3	9.3	10.4	10.4	10.4	10.5	10.5	11.8	11.8	11.8	11.8	13.4	13.4	13.4	13.4	13.4
		Hi PR	232	233	234	238	238	268	269	270	274	274	306	307	308	312	312	347	348	349	353	353	391	392	393	397	397	438	439	440	444
		Lo PR	122	124	127	132	132	130	131	134	139	139	136	138	141	146	146	141	141	146	151	151	147	148	151	157	153	155	158	163	163
		MBh	36.4	36.9	37.9	39.5	39.5	36.0	36.5	37.6	39.2	39.2	35.1	35.6	36.7	38.3	38.3	33.5	34.0	35.1	36.7	36.7	31.6	32.1	33.1	34.8	34.8	29.8	30.3	31.4	33.0
		S/T	0.84	0.76	0.63	0.5	0.5	0.85	0.77	0.63	0.5	0.5	1.00	0.80	0.66	0.5	0.5	1.00	0.82	0.68	0.5	0.5	1.00	0.84	0.70	0.6	1.00	1.00	0.75	0.6	
		ΔT	21	19	16	13	13	21	19	16	12	12	21	19	16	13	13	21	19	16	12	12	21	19	16	12	22	20	17	13.3	13.3
		kW	1.79	1.78	1.78	1.8	1.8	2.01	2.00	2.00	2.0	2.0	2.25	2.25	2.25	2.3	2.3	2.52	2.52	2.51	2.5	2.5	2.82	2.81	2.81	2.8	2.8	3.16	3.16	3.16	3.2
		Amps	7.1	7.1	7.1	7.2	7.2	8.1	8.1	8.1	8.2	9.3	9.2	9.2	9.2	9.3	9.3	10.5	10.5	10.4	10.5	10.5	11.8	11.8	11.8	11.8	13.4	13.4	13.4	13.5	13.5
		Hi PR	233	234	236	240	240	269	270	272	276	276	307	308	310	314	314	348	349	351	355	355	392	393	395	399	399	439	440	442	446
		Lo PR	124	125	129	134	134	131	133	136	141	141	138	139	142	147	147	143	145	148	153	153	148	150	153	158	155	157	160	165	165

IDB: Entering Indoor Dry Bulb Temperature
 High and low pressures are measured at the liquid and suction service valves.
 Shaded area reflects ACCA (TVA) conditions
 kW = Total system power
 Amps = outdoor unit amps (compressor + fan)

EXPANDED COOLING DATA — DZ18TC0361C* / CA*F3743*6D*+MBVC1600** -1A*+TX (HIGH STAGE)

DESIGN SUBCOOLING 5 - 7 °F @ THE LIQUID SERVICE VALVE, ARI 95 TEST CONDITIONS

IDB		OUTDOOR AMBIENT TEMPERATURE																															
		65°F					75°F					85°F					95°F					105°F					115°F						
		59	63	67	71	75	59	63	67	71	75	59	63	67	71	75	59	63	67	71	75	59	63	67	71	75	59	63	67	71	75		
		ENTERING INDOOR WET BULB TEMPERATURE																															
		AIRFLOW																															
80	1050	35.6	36.1	37.1	38.7	35.2	35.7	36.8	38.4	34.3	34.8	35.9	37.5	32.7	33.2	34.3	35.9	30.8	31.3	31.8	32.9	34.5	30.8	31.3	31.8	32.3	32.3	34.0	29.0	29.5	30.6	32.2	
		S/T	0.87	0.79	0.65	0.5	1.00	0.80	0.66	0.5	1.00	0.82	0.68	0.5	1.00	0.84	0.70	0.6	1.00	1.00	1.00	0.80	0.7	1.00	1.00	1.00	0.73	0.6	1.00	1.00	0.78	0.6	
		ΔT	27	25	22	18	27	25	22	18	27	25	22	19	27	25	22	18	26	25	24	20	17	26	25	24	20	17	26	25	21	18.0	
		kW	1.77	1.76	1.76	1.8	1.99	1.98	1.98	2.0	2.23	2.23	2.23	2.2	2.50	2.50	2.49	2.5	2.80	2.79	2.79	2.8	2.8	2.80	2.79	2.79	2.8	2.8	3.14	3.14	3.2	19.2	
		Amps	7.0	7.0	7.0	7.1	8.0	8.0	8.0	8.1	9.2	9.2	9.1	9.2	10.4	10.4	10.4	10.4	11.7	11.7	11.7	11.8	11.8	11.7	11.7	11.7	11.8	13.3	13.3	13.3	13.4	3.2	
		Hi PR	230	231	232	236	266	267	269	273	304	305	307	311	345	346	347	351	389	390	390	391	395	389	390	390	391	395	436	437	438	442	442
		Lo PR	121	122	125	131	128	130	133	138	135	136	139	144	140	142	145	150	145	145	147	150	155	145	147	147	150	155	152	154	157	162	162
		1220	36.1	36.6	37.6	39.2	35.8	36.3	37.3	38.9	34.8	35.3	36.4	38.0	33.2	33.7	34.8	36.4	31.3	31.8	32.3	32.9	34.5	31.3	31.8	32.3	33.3	34.9	30.0	30.5	31.6	33.2	32.7
		S/T	1.00	0.86	0.72	0.6	1.00	0.87	0.73	0.6	1.00	0.89	0.75	0.6	1.00	0.91	0.77	0.6	1.00	1.00	1.00	0.80	0.7	1.00	1.00	1.00	0.83	0.7	1.00	1.00	0.85	0.7	0.7
		ΔT	26	24	21	17	26	24	21	17	26	24	21	17	26	24	21	17	25	24	24	20	17	25	24	20	16	26	24	21	17.2	18.0	
	kW	1.78	1.78	1.77	1.8	2.00	2.00	1.99	2.0	2.24	2.24	2.24	2.3	2.51	2.51	2.51	2.5	2.81	2.81	2.80	2.8	2.8	2.81	2.81	2.80	2.8	2.8	3.16	3.16	3.15	3.2	3.2	
	Amps	7.1	7.1	7.1	7.1	8.1	8.1	8.1	8.1	9.2	9.2	9.2	9.3	10.4	10.4	10.4	10.5	11.8	11.8	11.8	11.8	11.9	11.8	11.8	11.8	11.9	13.4	13.4	13.4	13.4	13.4	13.4	
	Hi PR	232	233	235	239	268	269	271	275	306	307	309	313	347	348	350	354	391	392	392	394	398	391	392	392	394	398	438	439	441	445	445	
	Lo PR	123	124	127	133	130	132	135	140	137	138	141	146	142	144	147	152	147	149	149	152	157	147	149	149	152	157	154	156	159	164	164	
	1350	36.5	37.0	38.1	39.7	36.2	36.7	37.8	39.4	35.3	35.8	36.9	38.5	33.7	34.2	35.3	36.9	31.8	32.3	32.3	33.3	34.9	31.8	32.3	32.3	33.3	34.9	30.0	30.5	31.6	33.2	32.7	
	S/T	1.00	0.89	0.75	0.6	1.00	0.90	0.76	0.6	1.00	0.92	0.79	0.6	1.00	0.94	0.81	0.7	1.00	1.00	1.00	0.83	0.7	1.00	1.00	1.00	0.83	0.7	1.00	1.00	0.88	0.7	0.7	
	ΔT	25	23	20	16	25	23	20	16	25	23	20	17	25	23	20	16	25	23	23	20	16	25	23	20	16	26	24	21	17.2	18.0		
	kW	1.79	1.79	1.78	1.8	2.01	2.01	2.00	2.0	2.25	2.25	2.25	2.3	2.52	2.52	2.51	2.5	2.82	2.82	2.81	2.8	2.8	2.82	2.82	2.81	2.8	2.8	3.17	3.16	3.16	3.2	3.2	
	Amps	7.1	7.1	7.1	7.2	8.1	8.1	8.1	8.2	9.3	9.3	9.2	9.3	10.5	10.5	10.5	10.5	11.8	11.8	11.8	11.8	11.9	11.8	11.8	11.8	11.9	13.4	13.4	13.4	13.4	13.5	13.5	
	Hi PR	234	235	236	240	270	271	272	276	308	309	310	314	349	350	351	355	393	394	394	395	399	393	394	394	395	399	440	441	442	446	446	
	Lo PR	124	126	129	134	132	133	136	142	138	140	143	148	144	145	148	153	149	150	150	154	159	149	150	150	154	159	156	157	160	165	165	
85	1050	36.2	36.7	37.7	39.3	35.8	36.3	37.4	39.0	34.9	35.4	36.5	38.1	33.3	33.8	34.9	36.5	31.4	31.9	32.4	33.5	35.1	31.4	31.9	32.4	33.5	35.1	30.1	30.6	31.7	33.3	32.8	
		S/T	1.00	0.89	0.76	0.6	1.00	0.90	0.76	0.6	1.00	1.00	0.79	0.6	1.00	1.00	0.81	0.7	1.00	1.00	1.00	0.83	0.7	1.00	1.00	1.00	0.90	0.8	1.00	1.00	1.00	0.8	
		ΔT	30	28	25	22	30	28	25	22	30	29	25	22	30	28	25	22	30	28	25	22	30	28	25	22	31	29	26	26	22.6	22.6	
		kW	1.77	1.77	1.76	1.8	1.99	1.99	1.98	2.0	2.24	2.23	2.23	2.2	2.50	2.50	2.50	2.5	2.80	2.80	2.79	2.8	2.8	2.80	2.80	2.79	2.8	2.8	3.15	3.15	3.14	3.2	3.2
		Amps	7.0	7.0	7.0	7.1	8.1	8.0	8.0	8.1	9.2	9.2	9.2	9.2	10.4	10.4	10.4	10.5	11.8	11.8	11.8	11.8	11.9	11.8	11.8	11.7	11.8	13.4	13.4	13.3	13.4	13.4	13.4
		Hi PR	231	232	233	237	267	268	270	274	305	306	308	312	346	347	348	352	390	391	391	392	396	390	391	391	392	396	437	438	439	443	443
		Lo PR	123	124	127	132	130	131	135	140	136	138	141	146	142	143	146	152	147	149	149	152	157	147	149	149	152	157	154	155	158	164	164
		1220	36.7	37.2	38.2	39.8	36.4	36.9	37.9	39.5	35.4	35.9	37.0	38.6	33.8	34.3	35.4	37.0	31.9	32.4	32.4	33.5	35.1	31.9	32.4	32.4	33.5	35.1	30.1	30.6	31.7	33.3	32.8
		S/T	1.00	0.96	0.83	0.7	1.00	0.97	0.83	0.7	1.00	1.00	0.86	0.7	1.00	1.00	0.88	0.7	1.00	1.00	1.00	0.90	0.8	1.00	1.00	1.00	0.90	0.8	1.00	1.00	1.00	0.8	0.8
		ΔT	29	27	24	21	29	27	24	21	29	27	24	21	29	27	24	21	29	27	27	24	21	29	27	24	21	30	28	25	21.4	21.4	21.4
	kW	1.78	1.78	1.78	1.8	2.00	2.00	2.00	2.0	2.25	2.25	2.24	2.3	2.52	2.51	2.51	2.5	2.81	2.81	2.81	2.8	2.8	2.81	2.81	2.81	2.8	2.8	3.16	3.16	3.16	3.2	3.2	
	Amps	7.1	7.1	7.1	7.2	8.1	8.1	8.1	8.2	9.2	9.2	9.2	9.3	10.5	10.5	10.4	10.5	11.8	11.8	11.8	11.8	11.9	11.8	11.8	11.8	11.9	13.4	13.4	13.4	13.5	13.5	13.5	
	Hi PR	233	234	236	240	269	270	272	276	307	308	310	314	348	349	351	355	392	393	393	395	399	392	393	393	395	399	439	440	442	446	446	
	Lo PR	125	126	129	134	132	133	137	142	138	140	143	148	144	145	148	154	149	151	151	154	159	149	151	151	154	159	156	157	160	166	166	
	1350	37.1	37.6	38.7	40.3	36.8	37.3	38.4	40.0	35.9	36.4	37.5	39.1	34.3	34.8	35.9	37.5	32.4	32.9	32.9	33.9	35.5	32.4	32.9	32.9	33.9	35.5	30.6	31.1	32.1	33.8	33.3	
	S/T	1.00	0.99	0.86	0.7	1.00	1.00	0.86	0.7	1.00	1.00	0.89	0.7	1.00	1.00	0.91	0.8	1.00	1.00	1.00	0.93	0.8	1.00	1.00	1.00	0.93	0.8	1.00	1.00	1.00	0.8	0.8	
	ΔT	28	27	23	20	28	26	23	20	28	27	23	20	28	26	23	20	28	26	23	20	28	26	23	20	28	25	22	24	20.6	20.6	20.6	
	kW	1.79	1.79	1.79	1.8	2.01	2.01	2.01	2.0	2.26	2.26	2.25	2.3	2.52	2.52	2.52	2.5	2.82	2.82	2.82	2.8	2.8	2.82	2.82	2.82	2.8	2.8	3.17	3.17	3.16	3.2	3.2	
	Amps	7.1	7.1	7.1	7.2	8.2	8.1	8.1	8.2	9.3	9.3	9.3	9.3	10.5	10.5	10.5	10.5	11.9	11.9	11.9	11.8	11.9	11.9	11.9	11.8	11.9	13.5	13.4	13.4	13.5	13.5	13.5	
	Hi PR	235	236	237	241	271	272	273	277	309	310	311	315	350	351	352	356	394	395	395	396	400	394	395	395	396	400	441	442	443	447	447	
	Lo PR	126	128	131	136	134	135	138	143	140	142	145	150	145	147	150	155	151	152	152	155	161	151	152	152	155	161	157	159	162	167	167	

IDB: Entering Indoor Dry Bulb Temperature
 High and low pressures are measured at the liquid and suction service valves.
 Shaded area reflects AHRI conditions
 kW = Total system power
 Amps = outdoor unit amps (compressor + fan)

EXPANDED COOLING DATA — DZ18TC0481C* / CA*F4961*6D*+MBVC2000** -1A*+TXV (LOW STAGE)

DESIGN SUBCOOLING 5 - 7 °F @ THE LIQUID SERVICE VALVE, ARI 95 TEST CONDITIONS

IDB		OUTDOOR AMBIENT TEMPERATURE												105°F												115°F																					
		65°F						75°F						85°F						95°F						105°F						115°F															
		ENTERING INDOOR WET BULB TEMPERATURE																																													
AIRFLOW	59	63	67	71	59	63	67	71	59	63	67	71	59	63	67	71	59	63	67	71	59	63	67	71	59	63	67	71																			
70	1050	MBh	36.1	36.6	37.7	-	35.8	36.3	37.4	-	34.8	35.4	36.4	-	33.2	33.7	34.8	-	31.3	31.8	32.8	-	29.5	30.0	31.0	-	31.3	31.8	32.8	-	29.5	30.0	31.0	-	31.3	31.8	32.8	-	29.5	30.0	31.0	-					
	S/T	0.64	0.56	0.43	-	0.65	0.57	0.43	-	0.67	0.60	0.46	-	1.00	0.62	0.48	-	1.00	0.64	0.50	-	1.00	0.69	0.55	-	1.00	0.64	0.50	-	1.00	0.69	0.55	-	1.00	0.64	0.50	-	1.00	0.69	0.55	-						
	ΔT	20	18	14	-	20	18	14	-	20	18	15	-	20	18	14	-	19	18	14	-	21	19	15	-	19	18	14	-	21	19	15	-	19	18	14	-	21	19	15	-						
	kW	1.85	1.85	1.84	-	2.10	2.10	2.10	-	2.39	2.38	2.38	-	2.69	2.69	2.69	-	3.04	3.04	3.03	-	3.44	3.44	3.43	-	3.04	3.04	3.03	-	3.44	3.44	3.43	-	3.04	3.04	3.03	-	3.44	3.44	3.43	-						
	Amps	7.8	7.8	7.8	-	9.0	9.0	8.9	-	10.3	10.3	10.2	-	11.7	11.7	11.7	-	13.3	13.3	13.2	-	15.1	15.1	15.1	-	13.3	13.2	13.2	-	15.1	15.1	15.1	-	13.3	13.2	13.2	-	15.1	15.1	15.1	-						
	Hi PR	230	231	233	-	266	267	269	-	304	305	307	-	345	346	348	-	389	390	392	-	436	437	439	-	389	390	392	-	436	437	439	-	389	390	392	-	436	437	439	-						
	Lo PR	127	129	132	-	135	136	139	-	141	143	146	-	147	149	152	-	153	154	157	-	160	161	164	-	153	154	157	-	160	161	164	-	153	154	157	-	160	161	164	-						
	1150	MBh	36.4	37.0	38.0	-	36.1	36.6	37.7	-	35.2	35.7	36.8	-	33.6	34.1	35.1	-	31.6	32.1	33.2	-	29.8	30.3	31.4	-	31.6	32.1	33.2	-	29.8	30.3	31.4	-	31.6	32.1	33.2	-	29.8	30.3	31.4	-					
	S/T	0.68	0.60	0.46	-	0.69	0.61	0.47	-	0.71	0.64	0.50	-	1.00	0.66	0.52	-	1.00	0.68	0.54	-	1.00	0.73	0.59	-	1.00	0.68	0.54	-	1.00	0.73	0.59	-	1.00	0.68	0.54	-	1.00	0.73	0.59	-						
	ΔT	19	17	14	-	19	17	14	-	19	17	14	-	19	17	14	-	19	17	13	-	20	18	15	-	19	17	13	-	20	18	15	-	19	17	13	-	20	18	15	-						
kW	1.86	1.85	1.85	-	2.11	2.11	2.10	-	2.39	2.39	2.39	-	2.70	2.70	2.70	-	3.05	3.04	3.04	-	3.45	3.45	3.44	-	3.05	3.04	3.04	-	3.45	3.45	3.44	-	3.05	3.04	3.04	-	3.45	3.45	3.44	-							
Amps	7.9	7.8	7.8	-	9.0	9.0	9.0	-	10.3	10.3	10.3	-	11.7	11.7	11.7	-	13.3	13.3	13.3	-	15.1	15.1	15.1	-	13.3	13.3	13.3	-	15.1	15.1	15.1	-	13.3	13.3	13.3	-	15.1	15.1	15.1	-							
Hi PR	231	232	234	-	268	269	270	-	306	307	308	-	347	348	349	-	391	392	393	-	438	439	440	-	391	392	393	-	438	439	440	-	391	392	393	-	438	439	440	-							
Lo PR	128	130	133	-	136	138	141	-	143	144	147	-	148	150	153	-	154	156	159	-	161	163	166	-	154	156	159	-	161	163	166	-	154	156	159	-	161	163	166	-							
1350	MBh	37.3	37.8	38.8	-	36.9	37.5	38.5	-	36.0	36.5	37.6	-	34.4	34.9	36.0	-	32.4	32.9	34.0	-	30.6	31.1	32.2	-	32.4	32.9	34.0	-	30.6	31.1	32.2	-	32.4	32.9	34.0	-	30.6	31.1	32.2	-						
S/T	0.72	0.65	0.51	-	0.73	0.65	0.51	-	1.00	0.68	0.54	-	1.00	0.70	0.56	-	1.00	0.72	0.58	-	1.00	1.00	0.63	-	1.00	0.72	0.58	-	1.00	1.00	0.63	-	1.00	0.72	0.58	-	1.00	1.00	0.63	-							
ΔT	18	16	12	-	18	16	12	-	18	16	13	-	18	16	12	-	17	16	12	-	19	17	13	-	17	16	12	-	19	17	13	-	17	16	12	-	19	17	13	-							
kW	1.87	1.87	1.86	-	2.13	2.12	2.12	-	2.41	2.41	2.40	-	2.72	2.72	2.71	-	3.06	3.06	3.05	-	3.46	3.46	3.46	-	3.06	3.06	3.05	-	3.46	3.46	3.46	-	3.06	3.06	3.05	-	3.46	3.46	3.46	-							
Amps	7.9	7.9	7.9	-	9.1	9.1	9.1	-	10.4	10.4	10.4	-	11.8	11.8	11.8	-	13.4	13.4	13.3	-	15.2	15.2	15.2	-	13.4	13.4	13.3	-	15.2	15.2	15.2	-	13.4	13.4	13.3	-	15.2	15.2	15.2	-							
Hi PR	234	235	237	-	270	271	273	-	308	309	311	-	349	350	352	-	393	394	396	-	440	441	443	-	393	394	396	-	440	441	443	-	393	394	396	-	440	441	443	-							
Lo PR	131	133	136	-	139	140	144	-	146	147	150	-	151	153	156	-	157	158	162	-	164	165	169	-	157	158	162	-	164	165	169	-	157	158	162	-	164	165	169	-							

75	1050	MBh	36.1	36.6	37.7	39.4	35.8	36.3	37.4	39.0	34.9	35.4	36.4	38.1	33.3	33.8	34.8	36.5	31.3	31.8	32.9	34.5	29.5	30.0	31.1	32.7	31.3	31.8	32.9	34.5	29.5	30.0	31.1	32.7	31.3	31.8	32.9	34.5	29.5	30.0	31.1	32.7	
	S/T	0.77	0.70	0.56	0.4	1.00	0.70	0.56	0.4	1.00	0.73	0.59	0.4	1.00	0.75	0.61	0.5	0.5	1.00	0.77	0.63	0.5	1.00	1.00	0.68	0.5	1.00	0.77	0.63	0.5	1.00	1.00	0.68	0.5	1.00	0.77	0.63	0.5	1.00	1.00	0.68	0.5	
	ΔT	24	22	19	15	24	22	18	15	24	22	19	15	24	22	18	15	24	22	18	15	25	23	19	15.8	24	22	18	15	25	23	19	15.8	24	22	18	15	25	23	19	15.8		
	kW	1.85	1.84	1.84	1.9	2.10	2.10	2.09	2.1	2.38	2.38	2.38	2.4	2.69	2.69	2.69	2.7	3.04	3.03	3.03	3.0	3.44	3.44	3.43	3.5	3.04	3.03	3.03	3.0	3.44	3.44	3.43	3.5	3.04	3.03	3.03	3.0	3.44	3.44	3.43	3.5		
	Amps	7.8	7.8	7.8	7.9	9.0	9.0	8.9	9.0	10.3	10.3	10.2	10.3	11.7	11.7	11.6	11.7	13.2	13.2	13.3	13.3	15.1	15.1	15.1	15.2	13.2	13.2	13.2	13.3	15.1	15.1	15.1	15.2	13.2	13.2	13.2	13.3	15.1	15.1	15.1	15.2		
	Hi PR	230	231	233	237	267	268	269	273	305	306	307	311	345	346	348	352	389	390	392	396	436	437	439	443	389	390	392	396	436	437	439	443	389	390	392	396	436	437	439	443		
	Lo PR	127	129	132	137	135	136	139	145	141	143	146	152	147	149	152	157	153	154	157	163	160	161	164	170	153	154	157	163	160	161	164	170	153	154	157	163	160	161	164	170		
	1150	MBh	36.5	37.0	38.0	39.7	36.1	36.7	37.7	39.4	35.2	35.7	36.8	38.4	33.6	34.1	35.2	36.8	36.8	31.6	32.1	33.2	34.8	29.8	30.3	31.4	33.0	31.6	32.1	33.2	34.8	29.8	30.3	31.4	33.0	31.6	32.1	33.2	34.8	29.8	30.3	31.4	33.0
	S/T	0.81	0.74	0.60	0.5	1.00	0.74	0.60	0.5	1.00	0.77	0.63	0.5	1.00	0.79	0.65	0.5	0.5	1.00	0.77	0.63	0.5	1.00	1.00	0.72	0.6	1.00	0.79	0.65	0.5	1.00	1.00	0.72	0.6	1.00	0.79	0.65	0.5	1.00	1.00	0.72	0.6	
	ΔT	23	21	18	14	23	21	18	14	23	21	18	14	23	21	18	14	23	21	18	14	24	22	19	15.0	23	21	18	14	24	22	19	15.0	23	21	18	14	24	22	19	15.0		
kW	1.85	1.85	1.85	1.9	2.11	2.11	2.10	2.1	2.39	2.39	2.39	2.4	2.70	2.70	2.69	2.7	3.04	3.04	3.04	3.1	3.45	3.45	3.44	3.5	3.04	3.04	3.04	3.1	3.45	3.45	3.44	3.5	3.04	3.04	3.04	3.1	3.45	3.45	3.44	3.5			
Amps	7.8	7.8	7.8	7.9	9.0	9.0	9.0	9.1	10.3	10.3	10.3	10.4	11.7	11.7	11.7	11.8	13.3	13.3	13.3	13.3	15.1	15.1	15.1	15.2	13.3	13.3	13.3	13.3	15.1	15.1	15.1	15.2	13.3	13.3	13.3	13.3	15.1	15.1	15.1	15.2			
Hi PR	232	233	234	238	268	269	271	275	306	307	308	312	347	348	349	353	391	392	393	397	438	439	440	444	391	392	393	397	438	439	440	444	391	392	393	397	438	439	440	444			
Lo PR	128	130	133	138	136	138	141	146	143	144	148	153	148	150	153	159	154	156	159	164	161	163	166	171	154	156	159	164	161	163	166	171	154	156	159	164	1						

EXPANDED COOLING DATA — DZ18TC0481C*/CA*F3743*6**+TXV/MBVC2000** (HIGH STAGE)

DESIGN SUBCOOLING 5 - 7 °F @ THE LIQUID SERVICE VALVE, ARI 95 TEST CONDITIONS

IDB		OUTDOOR AMBIENT TEMPERATURE																																															
		65°F								75°F								85°F								95°F								105°F								115°F							
		AIRFLOW		59	63	67	71	59	63	67	71	ENTERING INDOOR WET BULB TEMPERATURE				59	63	67	71	ENTERING INDOOR WET BULB TEMPERATURE				59	63	67	71	ENTERING INDOOR WET BULB TEMPERATURE				59	63	67	71	ENTERING INDOOR WET BULB TEMPERATURE				59	63	67	71						
70	1400	MBh	50.0	50.7	52.2	-	49.6	50.3	51.8	-	48.2	49.0	50.5	-	46.0	46.7	48.2	-	43.2	43.9	45.4	-	40.7	41.4	42.9	-	38.2	38.9	40.4	-	35.7	36.4	37.9	-	33.2	33.9	35.4	-	30.7	31.4	32.9	-							
	S/T	0.58	0.50	0.36	-	0.59	0.51	0.36	-	0.61	0.53	0.39	-	0.63	0.55	0.41	-	0.65	0.57	0.43	-	0.67	0.59	0.45	-	0.69	0.61	0.47	-	0.71	0.63	0.49	-	0.73	0.65	0.51	-	0.75	0.67	0.53	-								
	ΔT	20	18	15	-	20	18	15	-	20	18	15	-	20	18	15	-	20	18	14	-	20	18	14	-	20	18	14	-	20	18	14	-	20	18	14	-	20	18	14	-								
	kW	2.70	2.70	2.70	-	3.04	3.04	3.03	-	3.41	3.41	3.40	-	3.82	3.81	3.81	-	4.27	4.27	4.26	-	4.72	4.71	4.70	-	5.17	5.16	5.15	-	5.62	5.61	5.60	-	6.07	6.06	6.05	-	6.52	6.51	6.50	-								
	Amps	10.5	10.5	10.5	-	12.0	12.0	12.0	-	13.7	13.7	13.7	-	15.6	15.6	15.6	-	17.7	17.7	17.6	-	19.8	19.8	19.7	-	21.9	21.9	21.8	-	24.0	24.0	23.9	-	26.1	26.1	26.0	-	28.2	28.2	28.1	-								
	Hi PR	243	245	246	-	282	283	285	-	323	324	325	-	366	367	369	-	413	414	416	-	463	464	466	-	513	514	516	-	563	564	566	-	613	614	616	-	663	664	666	-								
	Lo PR	122	123	126	-	129	131	134	-	136	137	140	-	141	143	146	-	147	148	151	-	153	154	157	-	159	160	163	-	165	166	169	-	171	172	175	-	177	178	181	-								
	7500	MBh	50.6	51.3	52.8	-	50.1	50.8	52.3	-	48.8	49.5	51.0	-	46.5	47.2	48.7	-	43.8	44.5	46.0	-	41.2	41.9	43.5	-	38.5	39.2	40.8	-	36.2	36.9	38.5	-	33.9	34.6	36.2	-	31.6	32.3	33.9	-							
	S/T	0.66	0.58	0.43	-	0.66	0.58	0.44	-	0.69	0.61	0.47	-	0.71	0.63	0.49	-	0.73	0.65	0.51	-	0.75	0.67	0.53	-	0.77	0.69	0.55	-	0.79	0.71	0.57	-	0.81	0.73	0.59	-	0.83	0.75	0.61	-								
	ΔT	19	17	14	-	19	17	14	-	19	17	14	-	19	17	14	-	19	17	13	-	18	16	13	-	18	16	13	-	18	16	13	-	18	16	13	-	18	16	13	-								
kW	2.72	2.72	2.71	-	3.06	3.05	3.05	-	3.43	3.43	3.42	-	3.84	3.83	3.83	-	4.29	4.28	4.28	-	4.74	4.73	4.72	-	5.19	5.18	5.17	-	5.64	5.63	5.62	-	6.09	6.08	6.07	-	6.54	6.53	6.52	-									
Amps	10.6	10.6	10.5	-	12.1	12.1	12.1	-	13.8	13.8	13.8	-	15.7	15.7	15.6	-	17.7	17.7	17.7	-	19.8	19.8	19.7	-	21.9	21.9	21.8	-	24.0	24.0	23.9	-	26.1	26.1	26.0	-	28.2	28.2	28.1	-									
Hi PR	245	247	248	-	284	285	287	-	325	326	327	-	368	369	371	-	415	416	418	-	465	466	468	-	515	516	518	-	565	566	568	-	615	616	618	-	665	666	668	-									
Lo PR	123	125	128	-	131	132	135	-	137	139	142	-	143	144	147	-	149	150	153	-	155	156	159	-	161	162	165	-	167	168	171	-	173	174	177	-													
75	1400	MBh	50.0	50.8	52.3	54.6	49.6	50.3	51.8	54.1	48.3	49.0	50.5	52.8	46.0	46.7	48.2	50.5	43.3	44.0	45.5	47.8	40.7	41.4	42.9	45.2	38.2	38.9	40.4	42.7	35.7	36.4	37.9	40.2	33.2	33.9	35.4	37.7											
S/T	0.71	0.63	0.49	0.3	0.72	0.64	0.50	0.3	0.72	0.64	0.50	0.3	0.74	0.66	0.52	0.3	0.76	0.68	0.54	0.3	0.78	0.70	0.56	0.3	0.80	0.72	0.58	0.3	0.82	0.74	0.60	0.3	0.84	0.76	0.62	0.3													
ΔT	24	22	19	15	24	22	19	15	24	22	19	15	24	22	19	15	24	22	19	15	24	22	19	15	24	22	19	15	24	22	19	15	24	22	19	15													
kW	2.70	2.70	2.69	2.7	3.04	3.03	3.03	3.1	3.41	3.41	3.40	3.4	3.81	3.81	3.81	3.8	4.27	4.26	4.26	4.3	4.72	4.71	4.70	4.7	5.17	5.16	5.15	5.2	5.62	5.61	5.60	5.7	6.07	6.06	6.05	6.2													
Amps	10.5	10.5	10.5	10.6	12.0	12.0	12.0	12.1	13.7	13.7	13.7	13.8	15.6	15.6	15.5	15.7	17.7	17.6	17.6	17.7	19.8	19.7	19.7	19.8	21.9	21.8	21.8	22.0	24.0	23.9	23.9	24.2	26.1	26.0	26.0	26.4													
Hi PR	244	245	246	251	282	283	285	289	323	324	326	330	366	367	369	373	413	414	416	420	463	464	466	471	513	514	516	520	563	564	566	571	613	614	616	621													
Lo PR	122	123	126	132	129	131	134	139	136	137	140	146	141	143	146	151	147	148	151	156	153	154	157	163	159	160	163	169	165	166	169	176	171	172	175	182													
7500	MBh	50.6	51.3	52.8	55.1	50.1	50.8	52.4	54.6	48.8	49.5	51.0	53.3	46.5	47.3	48.8	51.1	43.8	44.5	46.0	48.3	41.2	41.9	43.5	45.8	38.5	39.2	40.8	43.1	36.2	36.9	38.5	40.8																
S/T	0.79	0.71	0.57	0.4	0.80	0.72	0.58	0.4	0.80	0.72	0.58	0.4	0.82	0.74	0.60	0.5	0.84	0.76	0.62	0.5	0.86	0.78	0.64	0.5	0.88	0.80	0.66	0.5	0.90	0.82	0.68	0.5																	
ΔT	23	21	18	14	23	21	18	14	23	21	18	14	23	21	18	14	23	21	17	14	22	21	17	14	22	21	17	14	22	21	17	14																	
kW	2.72	2.72	2.71	2.7	3.05	3.05	3.05	3.1	3.43	3.43	3.42	3.4	3.83	3.83	3.82	3.9	4.28	4.28	4.28	4.3	4.73	4.72	4.71	4.7	5.18	5.17	5.16	5.2	5.63	5.62	5.61	5.7																	
Amps	10.6	10.6	10.5	10.7	12.1	12.1	12.1	12.2	13.8	13.8	13.8	13.9	15.7	15.7	15.6	15.7	17.7	17.7	17.7	17.8	19.8	19.7	19.7	19.8	21.9	21.8	21.8	22.0	24.0	23.9	23.9	24.2																	
Hi PR	246	247	248	253	284	285	287	291	325	326	328	332	368	369	371	375	415	416	418	422	466	467	469	473	516	517	519	523	567	568	570	574																	
Lo PR	123	125	128	133	131	132	135	141	137	139	142	147	143	144	147	153	148	150	153	158	155	156	159	165	161	162	165	171	167	168	171	177																	
7500	MBh	51.1	51.8	53.3	55.6	50.6	51.3	52.8	55.1	49.3	50.0	51.5	53.8	47.0	47.7	49.2	51.5	44.3	45.0	46.5	48.8	41.7	42.4	43.9	46.2	39.0	39.7	41.2	43.5	36.3	37.0	38.5	40.8																
S/T	0.83	0.75	0.61	0.5	0.84	0.76	0.62	0.5	0.84	0.76	0.62	0.5	0.86	0.78	0.64	0.5	0.88	0.80	0.66	0.5	0.90	0.82	0.68	0.5	0.92	0.84	0.70	0.5	0.94	0.86	0.72	0.5																	
ΔT	22	20	17	13	22	20	17	13	22	20	17	14	22	20	17	14	22	20	17	13	22	20	17	13	22	20	17	13	22	20	17	13																	
kW	2.73	2.73	2.72	2.7	3.07	3.06	3.06	3.1	3.44	3.44	3.43	3.5	3.84	3.84	3.84	3.9	4.30	4.29	4.29	4.3	4.75	4.74	4.73	4.7	5.20	5.19	5.18	5.2	5.65	5.64	5.63	5.7																	
Amps	10.6	10.6	10.6	10.7	12.2	12.1	12.1	12.2	13.9	13.9	13.8	14.0	15.7	15.7	15.6	15.8	17.8	17.8	17.8	17.9	19.9	19.8	19.8	19.9	22.0	21.9	21.9	22.1	24.1	24.0	24.0	24.3																	
Hi PR	247	248	250	254	286	287	289	293	326	327	329	333	370	371	373	377	417	418	420	424	467	468	470	474	517	518	520	524	567	568	570	574																	
Lo PR	125	126	129	134	132	133	137	142	139	140	143	148	144	146	149	154	149	151	154	159	156	157	160	166	162	163	166	172	168	169	172	178																	

IDB: Entering Indoor Dry Bulb Temperature
 High and low pressures are measured at the liquid and suction service valves.
 Shaded area reflects ACCA (TVA) conditions
 kW = Total system power
 Amps = outdoor unit amps (compressor + fan)

EXPANDED COOLING DATA — DZ18TC0481C* / CA *F4961*6D*+MBVC2000**-1A*+TXV (HIGH STAGE)

DESIGN SUBCOOLING 5 - 7 °F @ THE LIQUID SERVICE VALVE, ARI 95 TEST CONDITIONS

IDB		OUTDOOR AMBIENT TEMPERATURE												105°F												115°F											
		65°F						75°F						85°F						95°F						105°F						115°F					
		AIRFLOW		59	63	67	71	59	63	67	71	59	63	67	71	59	63	67	71	59	63	67	71	59	63	67	71	59	63	67	71						
80	1400	MBh	50.3	51.0	52.5	54.8	49.9	50.6	52.1	54.4	48.5	49.3	50.8	53.1	46.3	47.0	48.5	50.8	43.5	44.2	45.7	48.0	41.0	41.7	43.2	45.5	38.5	39.2	40.7	43.0	36.0	36.7	38.2	40.5			
		S/T	0.84	0.76	0.62	0.5	1.00	0.77	0.63	0.5	1.00	0.80	0.66	0.5	1.00	0.82	0.68	0.5	1.00	1.00	0.70	0.6	1.00	1.00	0.75	0.6	1.00	1.00	0.70	0.6	1.00	1.00	0.75	0.6			
		ΔT	28	26	23	19	28	26	23	19	28	26	23	19	28	26	23	19	27	26	24	21	27	26	24	21	26	25	23	20	25	24	22	19			
		kW	2.70	2.70	2.70	2.7	3.04	3.04	3.03	3.1	3.41	3.41	3.40	3.4	3.82	3.81	3.81	3.8	4.27	4.27	4.26	4.3	4.80	4.80	4.80	4.8	5.33	5.33	5.33	5.3	5.86	5.86	5.86	5.8			
		Amps	10.5	10.5	10.5	10.6	12.0	12.0	12.0	12.1	13.7	13.7	13.7	13.8	15.6	15.6	15.6	15.7	17.7	17.7	17.6	17.7	20.1	20.1	20.1	20.2	22.6	22.6	22.6	22.7	25.1	25.1	25.1	25.2			
		Hi PR	244	245	247	251	283	284	286	290	323	324	326	330	367	368	370	374	414	415	417	421	464	465	467	471	513	514	516	520	559	560	562	566			
	Lo PR	122	124	127	132	130	131	134	140	136	138	141	146	142	143	146	152	147	149	152	157	154	155	157	161	159	160	162	166	164	165	167	171				
	1600	MBh	50.8	51.6	53.1	55.4	50.4	51.1	52.6	54.9	49.1	49.8	51.3	53.6	46.8	47.5	49.0	51.3	44.1	44.8	46.3	48.6	41.5	42.2	43.7	46.0	39.0	39.7	41.2	43.5	36.5	37.2	38.7	41.0			
		S/T	1.00	0.84	0.70	0.6	1.00	0.85	0.71	0.6	1.00	0.87	0.73	0.6	1.00	0.89	0.75	0.6	1.00	1.00	0.78	0.6	1.00	1.00	0.83	0.7	1.00	1.00	0.78	0.6	1.00	1.00	0.83	0.7			
		ΔT	27	25	21	18	26	25	21	18	27	25	22	18	26	25	21	18	26	24	21	18	27	26	22	18.9	27	26	22	18.9	27	26	22	18.9			
		kW	2.72	2.72	2.71	2.7	3.06	3.05	3.05	3.1	3.43	3.43	3.42	3.4	3.83	3.83	3.83	3.9	4.29	4.28	4.28	4.3	4.82	4.81	4.81	4.8	5.35	5.35	5.35	5.3	5.88	5.88	5.88	5.8			
		Amps	10.6	10.6	10.5	10.7	12.1	12.1	12.1	12.2	13.8	13.8	13.8	13.9	15.7	15.7	15.6	15.8	17.7	17.7	17.7	17.8	20.2	20.2	20.1	20.3	22.7	22.7	22.7	22.8	25.2	25.2	25.2	25.3			
Hi PR		246	247	249	253	285	286	288	292	325	326	328	332	369	370	372	376	416	417	419	423	466	467	469	473	515	516	518	522	563	564	566	570				
Lo PR	124	125	128	134	131	133	136	141	138	139	142	148	143	145	148	153	149	150	153	159	156	157	160	165	161	162	165	170	166	167	171	176					
1750	MBh	51.3	52.0	53.5	55.8	50.9	51.6	53.1	55.4	49.5	50.3	51.8	54.1	47.3	48.0	49.5	51.8	44.5	45.2	46.7	49.0	42.0	42.7	44.2	46.5	39.5	40.2	41.7	44.0	37.0	37.7	39.2	41.5				
	S/T	1.00	0.88	0.74	0.6	1.00	0.89	0.75	0.6	1.00	0.91	0.77	0.6	1.00	1.00	0.79	0.6	1.00	1.00	0.82	0.7	1.00	1.00	0.87	0.7	1.00	1.00	0.82	0.7	1.00	1.00	0.87	0.7				
	ΔT	26	24	21	17	26	24	21	17	26	24	21	18	26	24	21	18	26	24	20	17	27	25	22	18.1	27	25	22	18.1	27	25	22	18.1				
	kW	2.73	2.73	2.72	2.8	3.07	3.07	3.06	3.1	3.44	3.44	3.43	3.5	3.85	3.84	3.84	3.9	4.30	4.30	4.29	4.3	4.83	4.83	4.83	4.8	5.36	5.36	5.36	5.3	5.89	5.89	5.89	5.8				
	Amps	10.6	10.6	10.6	10.7	12.2	12.2	12.1	12.2	13.9	13.9	13.8	14.0	15.7	15.7	15.6	15.7	17.8	17.8	17.8	17.9	20.3	20.2	20.2	20.3	22.8	22.8	22.8	22.9	25.3	25.3	25.3	25.4				
	Hi PR	248	249	250	255	286	287	289	293	327	328	329	334	370	371	373	377	417	418	420	424	467	468	470	474	516	517	519	523	565	566	568	572				
Lo PR	125	127	130	135	133	134	137	142	139	141	144	149	145	146	149	154	150	152	155	160	157	158	161	166	162	163	166	171	167	168	172	177					

85	1400	MBh	51.2	51.9	53.4	55.7	50.7	51.4	52.9	55.2	49.4	50.1	51.6	53.9	47.1	47.8	49.3	51.6	44.4	45.1	46.6	48.9	41.8	42.5	44.1	46.3	39.3	40.0	41.5	43.8
		S/T	1.00	0.87	0.73	0.6	1.00	0.88	0.74	0.6	1.00	1.00	0.76	0.6	1.00	1.00	0.78	0.6	1.00	1.00	0.81	0.7	1.00	1.00	0.86	0.7	1.00	1.00	0.81	0.7
		ΔT	31	29	26	23	31	29	26	23	31	30	26	23	31	29	26	23	31	29	26	22	32	30	27	23.4	32	30	27	23.4
		kW	2.71	2.71	2.70	2.7	3.04	3.04	3.04	3.1	3.42	3.42	3.41	3.4	3.82	3.82	3.81	3.8	4.27	4.27	4.27	4.3	4.80	4.80	4.80	4.8	5.33	5.33	5.33	5.3
		Amps	10.5	10.5	10.5	10.6	12.1	12.1	12.0	12.1	13.8	13.8	13.7	13.9	15.6	15.6	15.6	15.7	17.7	17.7	17.7	17.8	20.1	20.1	20.1	20.2	22.6	22.6	22.6	22.7
		Hi PR	245	246	248	252	284	285	287	291	324	325	327	331	368	369	371	375	415	416	418	422	465	466	468	472	514	515	517	521
	Lo PR	124	126	129	134	132	133	136	141	138	140	143	148	144	145	148	153	149	151	154	159	156	157	160	165	161	162	165	170	
	1600	MBh	51.7	52.4	53.9	56.2	51.2	52.0	53.5	55.8	49.9	50.6	52.1	54.4	47.7	48.4	49.9	52.2	44.9	45.6	47.1	49.4	42.4	43.1	44.6	46.9	40.0	40.7	42.2	44.5
		S/T	1.00	0.95	0.81	0.7	1.00	0.95	0.81	0.7	1.00	1.00	0.84	0.7	1.00	1.00	0.86	0.7	1.00	1.00	0.88	0.7	1.00	1.00	0.93	0.8	1.00	1.00	0.88	0.7
		ΔT	30	28	25	22	30	28	25	22	30	28	25	22	30	28	25	22	30	28	25	21	31	29	26	22.3	31	29	26	22.3
		kW	2.73	2.73	2.72	2.7	3.06	3.06	3.05	3.1	3.44	3.43	3.43	3.5	3.84	3.84	3.83	3.9	4.29	4.29	4.28	4.3	4.82	4.82	4.82	4.8	5.35	5.35	5.35	5.3
		Amps	10.6	10.6	10.6	10.7	12.1	12.1	12.1	12.2	13.9	13.8	13.8	13.9	15.7	15.7	15.7	15.8	17.8	17.8	17.7	17.9	20.2	20.2	20.2	20.3	22.7	22.7	22.7	22.8
Hi PR		247	248	250	254	286	287	289	293	326	327	329	333	370	371	373	377	417	418	420	424	467	468	470	474	516	517	519	523	
Lo PR	126	127	130	135	133	135	138	143	140	141	144	150	145	147	150	155	151	152	155	160	157	159	162	167	162	163	166	171		
1750	MBh	52.2	52.9	54.4	56.7	51.7	52.4	53.9	56.2	50.4	51.1	52.6	54.9	48.1	48.8	50.3	52.6	45.4	46.1	47.6	49.9	42.8	43.5	45.0	47.4	40.3	41.0	42.5	44.8	
	S/T	1.00	0.99	0.84	0.7	1.00	1.00	0.85	0.7	1.00	1.00	0.88	0.7	1.00	1.00	0.90	0.7	1.00	1.00	0.92	0.8	1.00	1.00	0.97	0.8	1.00	1.00	0.92	0.8	
	ΔT	29	28	24	21	29	27	24	21	29	28	24	21	29	27	24	21	29	27	24	21	30	28	25	21.6	30	28	25	21.6	
	kW	2.74	2.74	2.73	2.8	3.07	3.07	3.07	3.1	3.45	3.45	3.44	3.5	3.85	3.85	3.84	3.9	4.30	4.30	4.30	4.3	4.83	4.83	4.83	4.8	5.36	5.36	5.36	5.3	
	Amps	10.7	10.7	10.6	10.7	12.2	12.2	12.2	12.3	13.9	13.9	13.9	14.0	15.8	15.7	15.7	15.8	17.8	17.8	17.8	17.9	20.3	20.2	20.2	20.3	22.8	22.8	22.8	22.9	
	Hi PR	249	250	251	256	287	288	290	294	328	329	331	335	371	372	374	378	418	419	421	425	469	470	471	476	517	518	520	524	
Lo PR	127	128	132	137	134	136	139	144	141	142	146	151	146	148	151	156	152	153	156	161	159	160	163	168	164	165	168	173		

IDB: Entering Indoor Dry Bulb Temperature
 High and low pressures are measured at the liquid and suction service valves.
 Shaded area reflects AHRI conditions
 kW = Total system power
 Amps = outdoor unit amps (compressor + fan)

DESIGN SUBCOOLING 5 - 7 °F @ THE LIQUID SERVICE VALVE, ARI 95 TEST CONDITIONS

IDB		OUTDOOR AMBIENT TEMPERATURE												ENTERING INDOOR WET BULB TEMPERATURE											
		65°F				75°F				85°F				95°F				105°F				115°F			
		59	63	67	71	59	63	67	71	59	63	67	71	59	63	67	71	59	63	67	71	59	63	67	71
70	MBh	40.8	41.4	42.6	44.5	40.4	41.0	42.2	44.1	39.4	40.0	41.2	43.1	37.5	38.1	39.3	41.2	35.3	35.9	37.1	39.0	33.3	33.8	35.1	37.0
	S/T	0.59	0.52	0.39	0.4	0.60	0.53	0.39	0.42	0.63	0.55	0.42	0.4	0.64	0.57	0.44	0.4	1.00	0.59	0.46	0.4	1.00	0.64	0.51	0.4
	ΔT	21	19	15	16	21	19	15	16	21	19	15	16	21	19	15	16	20	18	15	15	22	20	16	16
	kW	2.19	2.18	2.18	2.2	2.50	2.49	2.49	2.5	2.84	2.84	2.84	2.84	3.22	3.22	3.21	3.21	3.64	3.64	3.63	3.63	4.13	4.13	4.12	4.12
	Amps	9.4	9.3	9.3	9.4	10.8	10.8	10.7	10.8	12.4	12.4	12.3	12.4	14.1	14.1	14.1	14.1	16.0	16.0	16.0	16.0	18.3	18.2	18.2	18.2
	Hi PR	234	235	237	241	271	272	273	275	309	310	312	314	351	352	354	356	396	397	399	399	444	445	447	447
	Lo PR	123	124	127	133	130	132	135	139	137	138	141	143	142	144	147	151	148	149	152	152	154	156	159	161
	MBh	41.3	41.9	43.1	45.0	41.0	41.6	42.8	44.7	39.9	40.5	41.7	43.6	38.1	38.7	39.9	41.8	35.8	36.4	37.6	39.5	33.8	34.4	35.6	37.5
	S/T	0.65	0.58	0.45	0.4	0.66	0.58	0.45	0.4	0.68	0.61	0.48	0.4	1.00	0.63	0.50	0.4	1.00	0.65	0.52	0.4	1.00	0.70	0.57	0.4
	ΔT	20	18	14	14	19	18	14	14	20	18	14	14	19	18	14	14	19	17	14	14	20	19	15	15
kW	2.20	2.20	2.19	2.2	2.51	2.51	2.50	2.5	2.86	2.86	2.85	2.85	3.24	3.23	3.23	3.23	3.65	3.65	3.65	3.65	4.15	4.14	4.14	4.14	
Amps	9.4	9.4	9.4	9.4	10.9	10.8	10.8	10.8	12.4	12.4	12.4	12.4	14.2	14.1	14.1	14.1	16.1	16.1	16.0	16.0	18.3	18.3	18.3	18.3	
Hi PR	236	237	239	241	273	274	275	275	311	312	314	316	353	354	356	356	398	399	401	401	446	447	449	449	
Lo PR	124	126	129	133	132	133	137	139	138	140	143	145	144	145	149	151	149	151	154	154	156	158	161	161	
MBh	42.0	42.6	43.8	45.7	41.6	42.2	43.4	45.3	40.6	41.1	42.4	44.3	38.7	39.3	40.5	42.4	36.5	37.1	38.3	40.2	34.4	35.0	36.2	38.1	
S/T	0.69	0.61	0.48	0.4	0.69	0.62	0.48	0.4	0.72	0.64	0.51	0.4	1.00	0.66	0.53	0.4	1.00	0.68	0.55	0.4	1.00	0.73	0.60	0.4	
ΔT	19	17	13	13	19	17	13	13	19	17	13	13	19	17	13	13	18	16	13	13	19	18	14	14	
kW	2.22	2.21	2.21	2.2	2.53	2.52	2.52	2.5	2.87	2.87	2.87	2.87	3.25	3.25	3.24	3.24	3.67	3.67	3.66	3.66	4.16	4.16	4.15	4.15	
Amps	9.5	9.5	9.5	9.5	10.9	10.9	10.9	10.9	12.5	12.5	12.5	12.5	14.2	14.2	14.2	14.2	16.1	16.1	16.1	16.1	18.4	18.4	18.4	18.4	
Hi PR	238	239	240	241	275	276	277	277	313	314	316	316	355	356	358	358	400	401	403	403	448	449	450	450	
Lo PR	126	128	131	136	134	135	139	139	140	142	145	145	146	147	151	151	151	153	156	156	158	160	163	163	

1050	MBh	40.8	41.4	42.6	44.5	40.5	41.0	42.3	44.1	39.4	40.0	41.2	43.1	37.6	38.1	39.4	41.2	35.3	35.9	37.1	39.0	33.3	33.9	35.1	36.9
	S/T	0.72	0.65	0.51	0.4	0.73	0.65	0.52	0.4	1.00	0.68	0.54	0.4	1.00	0.70	0.56	0.4	1.00	0.72	0.58	0.4	1.00	1.00	0.64	0.5
	ΔT	25	23	19	16	25	23	19	16	25	23	20	16	25	23	19	16	25	23	19	15	26	24	20	16.6
	kW	2.18	2.18	2.18	2.2	2.49	2.49	2.49	2.5	2.84	2.84	2.83	2.9	3.22	3.21	3.21	3.2	3.64	3.63	3.63	3.63	4.13	4.13	4.12	4.1
	Amps	9.3	9.3	9.3	9.4	10.8	10.8	10.7	10.8	12.4	12.3	12.3	12.4	14.1	14.1	14.0	14.2	16.0	16.0	16.0	16.0	18.2	18.2	18.2	18.3
	Hi PR	234	235	237	241	271	272	274	278	310	311	312	316	351	352	354	358	396	397	399	399	444	445	447	451
	Lo PR	123	124	127	133	130	132	135	140	137	138	141	147	142	144	147	152	148	149	152	157	154	156	159	164
	MBh	41.4	41.9	43.2	45.0	41.0	41.6	42.8	44.7	39.9	40.5	41.7	43.6	38.1	38.7	39.9	41.8	35.9	36.4	37.7	39.5	33.8	34.4	35.6	37.5
	S/T	0.78	0.71	0.57	0.4	0.79	0.71	0.58	0.4	1.00	0.74	0.60	0.5	1.00	0.76	0.62	0.5	1.00	0.78	0.64	0.5	1.00	1.00	0.69	0.6
	ΔT	24	22	18	15	24	22	18	15	24	22	18	15	24	22	18	14	23	22	18	14	25	23	19	15.4
kW	2.20	2.20	2.19	2.2	2.51	2.51	2.50	2.5	2.86	2.86	2.85	2.9	3.23	3.23	3.23	3.2	3.65	3.65	3.64	3.64	4.14	4.14	4.14	4.2	
Amps	9.4	9.4	9.4	9.5	10.8	10.8	10.8	10.9	12.4	12.4	12.4	12.5	14.2	14.1	14.1	14.2	16.1	16.1	16.0	16.0	18.3	18.3	18.3	18.4	
Hi PR	236	237	239	243	273	274	276	280	312	313	314	318	353	354	356	360	398	399	401	405	446	447	449	453	
Lo PR	124	126	129	134	132	133	137	142	138	140	143	148	144	145	149	154	149	151	154	159	156	158	161	166	
MBh	42.0	42.6	43.8	45.7	41.6	42.2	43.4	45.3	40.6	41.2	42.4	44.2	38.8	39.3	40.5	42.4	36.5	37.1	38.3	40.2	34.5	35.0	36.3	38.1	
S/T	0.81	0.74	0.61	0.5	1.00	0.74	0.61	0.5	1.00	0.77	0.64	0.5	1.00	0.79	0.66	0.5	1.00	0.81	0.68	0.5	1.00	1.00	0.73	0.6	
ΔT	23	21	17	14	23	21	17	14	23	21	18	14	23	21	17	14	22	21	17	13	24	22	18	14.5	
kW	2.21	2.21	2.21	2.2	2.52	2.52	2.52	2.5	2.87	2.87	2.86	2.9	3.25	3.24	3.24	3.3	3.67	3.66	3.66	3.66	4.16	4.16	4.15	4.2	
Amps	9.5	9.5	9.4	9.6	10.9	10.9	10.9	11.0	12.5	12.5	12.5	12.6	14.2	14.2	14.2	14.3	16.1	16.1	16.1	16.1	18.4	18.4	18.3	18.5	
Hi PR	238	239	241	245	275	276	278	282	314	315	316	320	355	356	358	362	400	401	403	407	448	449	451	455	
Lo PR	126	128	131	136	134	135	139	144	140	142	145	150	146	147	151	156	151	153	156	161	158	160	163	168	

IDB: Entering Indoor Dry Bulb Temperature
 High and low pressures are measured at the liquid and suction service valves.
 Shaded area reflects ACCA (TVA) conditions
 kW = Total system power
 Amps = outdoor unit amps (compressor + fan)

EXPANDED COOLING DATA — DZ18TC0601C* / CA*F4961*6D*+MBVC2000** -1A*+TXV (LOW STAGE)

DESIGN SUBCOOLING 5 - 7 °F @ THE LIQUID SERVICE VALVE, ARI 95 TEST CONDITIONS

IDB		OUTDOOR AMBIENT TEMPERATURE																																			
		65°F						75°F						85°F						95°F						105°F						115°F					
		59	63	67	71	71	59	63	67	71	71	59	63	67	71	71	59	63	67	71	71	59	63	67	71	71	59	63	67	71	71	59	63	67	71	71	
AIRFLOW		MBh	41.0	41.6	42.8	44.7	40.7	41.3	42.5	44.3	39.6	40.2	41.4	43.3	37.8	38.4	39.6	41.4	41.4	39.2	35.5	36.1	37.3	39.2	39.2	33.5	34.1	35.3	37.2	37.2	33.5	34.1	35.3	37.2	37.2		
		S/T	1.00	0.77	0.64	0.5	1.00	0.78	0.64	0.5	1.00	0.80	0.67	0.5	1.00	0.82	0.69	0.5	0.5	0.6	1.00	1.00	0.71	0.6	0.6	1.00	1.00	0.76	0.6	0.6	1.00	1.00	0.76	0.6	0.6		
		ΔT	29	27	24	20	29	27	24	20	29	27	24	20	29	27	24	20	20	20	29	27	23	20	20	30	28	25	20.8	20.8	30	28	25	20.8	20.8		
		kW	2.19	2.18	2.18	2.2	2.50	2.49	2.49	2.5	2.84	2.84	2.84	2.9	3.22	3.22	3.21	3.2	3.2	3.0	3.64	3.64	3.63	3.7	3.7	4.13	4.13	4.12	4.1	4.1	4.13	4.13	4.12	4.1	4.1		
		Amps	9.4	9.3	9.3	9.4	10.8	10.8	10.7	10.9	12.4	12.4	12.3	12.4	14.1	14.1	14.0	14.2	14.2	16.0	16.0	16.0	16.0	16.1	16.1	18.3	18.2	18.2	18.3	18.3	18.2	18.2	18.2	18.3	18.3		
		Hi PR	235	236	237	241	271	272	274	278	310	311	313	317	352	353	354	358	358	397	398	399	403	403	445	446	447	451	451	445	446	447	451	451	451		
		Lo PR	123	125	128	133	131	132	135	141	137	139	142	147	143	144	147	153	153	148	150	153	158	158	155	156	160	160	165	165	155	156	160	165	165		
		MBh	41.6	42.2	43.4	45.2	41.2	41.8	43.0	44.9	40.2	40.7	41.9	43.8	38.3	38.9	40.1	42.0	42.0	36.1	36.7	37.9	39.7	39.7	34.0	34.6	35.8	37.7	37.7	34.0	34.6	35.8	37.7	37.7			
		S/T	1.00	0.83	0.70	0.6	1.00	0.83	0.70	0.6	1.00	0.86	0.73	0.6	1.00	1.00	0.75	0.6	0.6	1.00	1.00	0.77	0.6	0.6	1.00	1.00	0.82	0.7	0.7	1.00	1.00	0.82	0.7	0.7			
		ΔT	28	26	23	19	28	26	22	19	28	26	23	19	28	26	22	19	19	28	26	22	18	18	29	27	23	19.7	19.7	29	27	23	19.7	19.7			
		kW	2.20	2.20	2.19	2.2	2.51	2.51	2.50	2.5	2.86	2.86	2.85	2.9	3.23	3.23	3.23	3.3	3.3	3.65	3.65	3.65	3.7	3.7	4.15	4.14	4.14	4.2	4.2	4.15	4.14	4.14	4.2	4.2	4.2		
		Amps	9.4	9.4	9.4	9.5	10.9	10.8	10.8	10.9	12.4	12.4	12.4	12.5	14.2	14.1	14.1	14.2	14.2	16.1	16.1	16.0	16.2	16.2	18.3	18.3	18.3	18.4	18.4	18.3	18.3	18.3	18.3	18.3	18.4		
		Hi PR	237	238	239	243	273	274	276	280	312	313	315	319	354	355	356	360	360	399	400	401	405	405	447	448	449	453	453	447	448	449	453	453	453		
		Lo PR	125	127	130	135	132	134	137	142	139	141	144	149	145	146	149	154	154	150	151	155	160	160	157	158	161	167	167	157	158	161	167	167	167		
		MBh	42.2	42.8	44.0	45.9	41.9	42.4	43.7	45.5	40.8	41.4	42.6	44.5	39.0	39.5	40.8	42.6	42.6	36.7	37.3	38.5	40.4	40.4	34.7	35.3	36.5	38.3	38.3	34.7	35.3	36.5	38.3	38.3			
		S/T	1.00	0.86	0.73	0.6	1.00	0.87	0.73	0.6	1.00	0.89	0.76	0.6	1.00	1.00	0.78	0.6	0.6	1.00	1.00	0.80	0.7	0.7	1.00	1.00	0.85	0.7	0.7	1.00	1.00	0.85	0.7	0.7			
		ΔT	27	25	22	18	27	25	21	18	27	25	22	18	27	25	21	18	18	27	25	21	18	18	28	26	22	18.7	18.7	28	26	22	18.7	18.7			
		kW	2.22	2.21	2.21	2.2	2.53	2.52	2.52	2.5	2.87	2.87	2.87	2.9	3.25	3.25	3.24	3.3	3.3	3.67	3.67	3.66	3.7	3.7	4.16	4.16	4.15	4.2	4.2	4.16	4.16	4.15	4.2	4.2	4.2		
		Amps	9.5	9.5	9.5	9.6	10.9	10.9	10.9	11.0	12.5	12.5	12.5	12.6	14.2	14.2	14.2	14.3	14.2	16.1	16.1	16.1	16.2	16.2	18.4	18.4	18.4	18.5	18.5	18.4	18.4	18.4	18.4	18.5	18.5		
		Hi PR	238	239	241	245	275	276	278	282	314	315	317	321	356	357	358	362	362	401	402	403	407	407	448	449	451	455	455	448	449	451	455	455	455		
		Lo PR	127	129	132	137	134	136	139	144	141	143	146	151	147	148	151	156	156	152	153	157	162	162	159	160	163	169	169	159	160	163	169	169	169		

		MBh	41.7	42.3	43.5	45.4	41.4	41.9	43.2	45.0	40.3	40.9	42.1	44.0	38.5	39.0	40.3	42.1	42.1	36.2	36.8	38.0	39.9	39.9	34.2	34.8	36.0	37.8	37.8	34.2	34.8	36.0	37.8	37.8	
		S/T	1.00	0.87	0.74	0.6	1.00	0.87	0.74	0.6	1.00	1.00	0.77	0.6	1.00	1.00	0.79	0.6	0.6	1.00	1.00	0.81	0.7	0.7	1.00	1.00	1.00	0.7	0.7	1.00	1.00	1.00	0.7	0.7	
		ΔT	33	31	27	24	33	31	27	24	33	31	28	24	33	31	27	24	24	33	31	27	23	23	34	32	28	24.6	24.6	34	32	28	24.6	24.6	
		kW	2.19	2.19	2.18	2.2	2.50	2.50	2.49	2.5	2.85	2.85	2.84	2.9	3.22	3.22	3.22	3.2	3.2	3.64	3.64	3.64	3.7	3.7	4.14	4.13	4.13	4.2	4.2	4.14	4.13	4.13	4.2	4.2	
		Amps	9.4	9.4	9.3	9.5	10.8	10.8	10.8	10.9	12.4	12.4	12.4	12.5	14.1	14.1	14.1	14.2	14.2	16.0	16.0	16.0	16.1	16.1	18.3	18.3	18.2	18.4	18.4	18.3	18.3	18.3	18.2	18.4	18.4
		Hi PR	236	237	238	242	273	274	275	279	311	312	314	318	353	354	356	360	360	398	399	400	404	404	446	447	448	452	452	446	447	448	452	452	
		Lo PR	125	127	130	135	132	134	137	142	139	141	144	149	145	146	149	154	154	150	151	155	160	160	157	158	161	167	167	157	158	161	167	167	
		MBh	42.3	42.8	44.1	45.9	41.9	42.5	43.7	45.6	40.8	41.4	42.6	44.5	39.0	39.6	40.8	42.7	42.7	36.8	37.3	38.6	40.4	40.4	34.7	35.3	36.5	38.4	38.4	34.7	35.3	36.5	38.4	38.4	
		S/T	1.00	0.93	0.79	0.7	1.00	1.00	0.80	0.7	1.00	1.00	0.83	0.7	1.00	1.00	0.84	0.7	0.7	1.00	1.00	0.87	0.7	0.7	1.00	1.00	1.00	0.8	0.8	1.00	1.00	1.00	0.8	0.8	
		ΔT	32	30	26	23	32	30	26	23	32	30	26	23	32	30	26	22	22	31	30	26	22	22	33	31	27	23.4	23.4	33	31	27	23.4	23.4	
		kW	2.21	2.21	2.20	2.2	2.52	2.52	2.51	2.5	2.87	2.86	2.86	2.9	3.24	3.24	3.23	3.3	3.3	3.66	3.66	3.65	3.7	3.7	4.15	4.15	4.14	4.2	4.2	4.15	4.15	4.14	4.2	4.2	
		Amps	9.5	9.4	9.4	9.5	10.9	10.9	10.8	11.0	12.5	12.5	12.4	12.5	14.2	14.2	14.2	14.3	14.2	16.1	16.1	16.1	16.2	16.2	18.4	18.3	18.3	18.4	18.4	18.4	18.3	18.3	18.3	18.4	18.4
		Hi PR	238	239	240	244	275	276	277	281	313	314	316	320	355	356	357	362	362	400	401	402	406	406	448	449	450	454	454	448	449	450	454	454	454
		Lo PR	127	128	131	137	134	136	139	144	141	142	145	151	146	148	151	156	156	152	153	156	162	162	159	160	163	168	168	159	160	163	168	168	168
		MBh	42.9	43.5	44.7	46.6	42.5	43.1	44.3	46.2	41.5	42.1	43.3	45.1	39.6	40.2	41.4	43.3	43.3	37.4	38.0	39.2	41.1	41.1	35.4	35.9	37.2	39.0	39.0	35.4	35.9	37.2	39.0	39.0	
		S/T	1.00	0.96	0.83	0.7	1.00	1.00	0.83	0.7	1.00	1.00	0.86	0.7	1.00	1.00	0.88	0.7	0.7	1.00	1.00	0.90	0.8	0.8	1.00	1.00	1.00	0.8	0.8	1.00	1.00	1.00	0.8	0.8	
		ΔT	31	29	25	22	31	29	25	22	31	29	26	22	31	29	25	22	22	30	29	25	21	21	32	30	26	22.5	22.5	32	30	26	22.5	22.5	
		kW	2.22	2.22	2.21	2.2	2.53	2.53	2.52	2.5	2.88	2.88	2.87	2.9	3.25	3.25	3.25	3.3	3.3	3.67	3.67	3.67	3.7	3.7	4.17	4.16	4.16	4.2	4.2	4.17	4.16	4.16	4.2	4.2	4.2
		Amps	9.5	9.5	9.5	9.6	10.9	10.9	10.9	11.0	12.5	12.5	12.5	12.6	14.2	14.2	14.2	14.3	14.2	16.2	16.2	16.1	16.2	16.2	18.4	18.4	18.4	18.5	18.5	18.4	18.4	18.4	18.4		

DESIGN SUBCOOLING 5 - 7 °F @ THE LIQUID SERVICE VALVE, ARI 95 TEST CONDITIONS

IDB		OUTDOOR AMBIENT TEMPERATURE																																			
		65°F						75°F						85°F						95°F						105°F						115°F					
		59	63	67	71	59	63	67	71	59	63	67	71	59	63	67	71	59	63	67	71	59	63	67	71	59	63	67	71								
AIRFLOW		ENTERING INDOOR WET BULB TEMPERATURE																																			
70	MBh	58.2	59.0	60.8	-	57.7	58.5	60.3	-	56.2	57.0	58.8	-	53.6	54.5	56.2	-	50.5	51.3	53.0	-	47.6	48.4	50.1	-	45.1	46.0	47.8	-								
	S/T	0.66	0.59	0.45	-	0.67	0.60	0.46	-	0.70	0.62	0.48	-	0.72	0.64	0.50	-	0.74	0.66	0.53	-	0.77	0.69	0.55	-	0.80	0.72	0.58	-								
	ΔT	18	17	13	-	18	17	13	-	19	17	14	-	18	17	13	-	18	16	13	-	19	17	13	-	19	17	13	-								
	1840 kW	3.23	3.22	3.22	-	3.63	3.63	3.62	-	4.08	4.08	4.07	-	4.57	4.56	4.56	-	5.11	5.11	5.10	-	5.75	5.75	5.74	-	6.40	6.40	6.39	-								
	Amps	12.7	12.7	12.7	-	14.6	14.6	14.5	-	16.6	16.6	16.6	-	18.9	18.9	18.8	-	21.4	21.3	21.3	-	24.3	24.3	24.2	-	27.2	27.2	27.1	-								
	Hi PR	250	251	253	-	289	290	292	-	330	331	333	-	375	376	377	-	422	423	425	-	473	474	476	-	520	521	523	-								
	Lo PR	118	120	123	-	126	127	130	-	132	133	136	-	137	138	141	-	142	144	147	-	149	150	153	-	156	157	160	-								
	MBh	58.9	59.7	61.4	-	58.3	59.1	60.9	-	56.8	57.6	59.4	-	54.3	55.1	56.8	-	51.1	51.9	53.6	-	48.2	49.0	50.7	-	45.9	46.7	48.4	-								
	S/T	0.69	0.61	0.48	-	0.70	0.62	0.49	-	0.72	0.65	0.51	-	0.74	0.67	0.53	-	0.76	0.69	0.55	-	0.79	0.72	0.58	-	0.82	0.75	0.61	-								
	ΔT	18	16	13	-	18	16	13	-	18	16	13	-	18	16	13	-	18	16	12	-	19	17	13	-	19	17	13	-								
2000 kW	3.24	3.23	3.23	-	3.64	3.64	3.63	-	4.09	4.09	4.08	-	4.58	4.58	4.57	-	5.12	5.12	5.11	-	5.76	5.76	5.75	-	6.44	6.44	6.43	-									
Amps	12.8	12.8	12.7	-	14.6	14.6	14.6	-	16.7	16.7	16.6	-	18.9	18.9	18.9	-	21.4	21.4	21.4	-	24.3	24.3	24.3	-	27.2	27.2	27.1	-									
Hi PR	252	253	254	-	291	292	294	-	332	333	335	-	376	377	379	-	424	425	426	-	474	475	477	-	522	523	525	-									
Lo PR	120	121	124	-	127	128	131	-	133	135	138	-	138	140	143	-	144	145	148	-	150	151	154	-	157	158	161	-									
MBh	60.0	60.8	62.5	-	59.5	60.3	62.0	-	58.0	58.8	60.5	-	55.4	56.2	57.9	-	52.2	53.0	54.8	-	49.3	50.2	51.9	-	47.0	47.9	49.6	-									
S/T	0.71	0.63	0.50	-	0.72	0.64	0.50	-	0.74	0.66	0.53	-	0.76	0.68	0.55	-	0.78	0.71	0.57	-	0.81	0.74	0.60	-	0.84	0.77	0.63	-									
ΔT	17	15	12	-	17	15	12	-	17	15	12	-	17	15	12	-	17	15	11	-	18	16	13	-	18	16	13	-									
2250 kW	3.26	3.25	3.25	-	3.66	3.66	3.65	-	4.11	4.11	4.10	-	4.60	4.59	4.59	-	5.14	5.14	5.13	-	5.78	5.78	5.77	-	6.46	6.46	6.45	-									
Amps	12.9	12.9	12.8	-	14.7	14.7	14.7	-	16.8	16.8	16.7	-	19.0	19.0	19.0	-	21.5	21.5	21.5	-	24.4	24.4	24.4	-	27.3	27.3	27.2	-									
Hi PR	254	255	257	-	293	294	296	-	334	335	337	-	378	379	381	-	426	427	429	-	477	478	479	-	525	526	528	-									
Lo PR	122	123	126	-	129	131	134	-	135	137	140	-	141	142	145	-	146	147	150	-	152	153	156	-	159	160	163	-									

1840	MBh	58.3	59.1	60.8	63.4	57.8	58.6	60.3	62.9	56.3	57.1	58.8	61.4	53.7	54.5	56.2	58.8	50.5	51.3	53.0	55.7	47.6	48.4	50.2	52.8
	S/T	0.79	0.72	0.58	0.4	0.80	0.72	0.59	0.4	0.82	0.75	0.61	0.5	1.00	0.77	0.63	0.5	1.00	0.79	0.66	0.5	1.00	0.84	0.71	0.6
	ΔT	22	21	17	14	22	21	17	14	23	21	17	14	22	21	17	14	22	20	17	13	23	21	18	14.6
	1840 kW	3.22	3.22	3.21	3.2	3.63	3.62	3.62	3.6	4.08	4.07	4.07	4.1	4.56	4.56	4.55	4.6	5.11	5.11	5.10	5.1	5.75	5.74	5.74	5.8
	Amps	12.7	12.7	12.7	12.8	14.6	14.6	14.5	14.7	16.6	16.6	16.6	16.7	18.9	18.8	18.8	19.0	21.4	21.3	21.3	21.4	24.3	24.3	24.2	24.4
	Hi PR	250	252	253	258	290	291	292	297	331	332	333	338	375	376	378	382	422	423	425	430	473	474	476	480
	Lo PR	118	120	123	128	126	127	130	135	132	133	136	141	137	139	141	146	142	144	147	152	149	150	153	158
	MBh	58.9	59.7	61.4	64.0	58.4	59.2	60.9	63.5	56.9	57.7	59.4	62.0	54.3	55.1	56.8	59.4	51.1	51.9	53.7	56.3	48.2	49.1	50.8	53.4
	S/T	0.82	0.74	0.61	0.5	0.83	0.75	0.61	0.5	0.85	0.78	0.64	0.5	1.00	0.79	0.66	0.5	1.00	0.82	0.68	0.5	1.00	0.87	0.73	0.6
	ΔT	22	20	17	13	22	20	17	13	22	20	17	13	22	20	17	13	22	20	16	13	23	21	17	13.9
2000 kW	3.24	3.23	3.23	3.3	3.64	3.64	3.63	3.7	4.09	4.09	4.08	4.1	4.58	4.57	4.57	4.6	5.12	5.12	5.11	5.1	5.76	5.76	5.75	5.8	
Amps	12.8	12.8	12.7	12.9	14.6	14.6	14.6	14.7	16.7	16.7	16.6	16.8	18.9	18.9	18.9	19.0	21.4	21.4	21.4	21.5	24.3	24.3	24.3	24.4	
Hi PR	252	253	255	259	291	292	294	298	332	333	335	339	376	377	379	383	424	425	427	431	475	476	477	482	
Lo PR	120	121	124	129	127	128	131	136	133	135	138	143	138	140	143	148	144	145	148	153	150	151	154	159	
MBh	60.0	60.8	62.5	65.2	59.5	60.3	62.0	64.7	58.0	58.8	60.5	63.1	55.4	56.2	57.9	60.6	52.3	53.1	54.8	57.4	49.4	50.2	51.9	54.5	
S/T	0.84	0.76	0.63	0.5	0.84	0.77	0.63	0.5	1.00	0.79	0.66	0.5	1.00	0.81	0.68	0.5	1.00	0.83	0.70	0.6	1.00	0.89	0.75	0.6	
ΔT	21	19	16	12	21	19	16	12	21	19	16	12	21	19	16	12	21	19	15	12	22	20	17	13.0	
2250 kW	3.25	3.25	3.24	3.3	3.66	3.65	3.65	3.7	4.11	4.10	4.10	4.1	4.59	4.59	4.58	4.6	5.14	5.14	5.13	5.2	5.78	5.77	5.77	5.8	
Amps	12.9	12.8	12.8	12.9	14.7	14.7	14.7	14.8	16.8	16.7	16.7	16.9	19.0	19.0	18.9	19.1	21.5	21.5	21.4	21.6	24.4	24.4	24.4	24.5	
Hi PR	254	255	257	261	293	294	296	300	334	335	337	341	378	380	381	386	426	427	429	433	477	478	480	484	
Lo PR	122	124	126	131	129	131	134	139	135	137	140	145	141	142	145	150	146	147	150	155	152	154	157	162	

IDB: Entering Indoor Dry Bulb Temperature
 High and low pressures are measured at the liquid and suction service valves.
 Shaded area reflects ACCA (TVA) conditions
 kW = Total system power
 Amps = outdoor unit amps (compressor + fan)

EXPANDED COOLING DATA — DZ18TC0601C* / CA*F4961*6D*+MBVC2000**-1A*+TXV (HIGH STAGE)

DESIGN SUBCOOLING 5 - 7 °F @ THE LIQUID SERVICE VALVE, ARI 95 TEST CONDITIONS

IDB		OUTDOOR AMBIENT TEMPERATURE												ENTERING INDOOR WET BULB TEMPERATURE															
		65°F				75°F				85°F				95°F				105°F				115°F							
		59	63	67	71	59	63	67	71	59	63	67	71	59	63	67	71	59	63	67	71	59	63	67	71				
80	AIRFLOW	59	63	67	71	59	63	67	71	59	63	67	71	59	63	67	71	59	63	67	71	59	63	67	71	59	63	67	71
	MBh	58.6	59.4	61.1	63.7	58.1	58.9	60.6	63.2	56.6	57.4	59.1	61.7	54.0	54.8	56.5	59.1	50.8	51.6	53.3	56.0	47.9	48.7	50.5	53.1				
	S/T	0.92	0.84	0.71	0.6	1.00	0.85	0.71	0.6	1.00	0.87	0.74	0.6	1.00	0.89	0.76	0.6	1.00	0.92	0.78	0.6	1.00	1.00	0.83	0.7				
	ΔT	26	25	21	18	26	25	21	18	27	25	22	18	26	24	21	17	26	24	21	17	27	26	22	18.6				
	kW	3.22	3.22	3.21	3.2	3.63	3.63	3.62	3.6	4.08	4.08	4.07	4.1	4.57	4.56	4.56	4.6	5.11	5.11	5.10	5.1	5.75	5.75	5.74	5.8				
	Amps	12.7	12.7	12.7	12.8	14.6	14.6	14.5	14.7	16.6	16.6	16.6	16.7	18.9	18.9	18.9	19.0	21.4	21.3	21.3	21.5	24.3	24.3	24.3	24.4				
	Hi PR	251	252	254	258	290	291	293	297	331	332	334	338	375	376	378	382	423	424	426	430	474	475	476	481				
	Lo PR	119	120	123	128	126	128	131	135	132	134	137	142	138	139	142	147	143	144	147	152	149	151	154	159				
	MBh	59.2	60.0	61.7	64.3	58.7	59.5	61.2	63.8	57.2	58.0	59.7	62.3	54.6	55.4	57.1	59.7	51.4	52.2	54.0	56.6	48.5	49.4	51.1	53.7				
	S/T	0.95	0.87	0.73	0.6	1.00	0.88	0.74	0.6	1.00	0.90	0.76	0.6	1.00	0.92	0.78	0.6	1.00	1.00	0.81	0.7	1.00	1.00	0.86	0.7				
ΔT	26	24	21	17	26	24	21	17	26	24	21	17	26	24	21	17	26	24	21	17	27	25	21	18.0					
kW	3.24	3.23	3.23	3.3	3.64	3.64	3.63	3.7	4.09	4.09	4.08	4.1	4.58	4.58	4.57	4.6	5.12	5.12	5.11	5.1	5.76	5.76	5.75	5.8					
Amps	12.8	12.8	12.7	12.9	14.6	14.6	14.6	14.7	16.7	16.7	16.6	16.8	18.9	18.9	18.9	19.0	21.4	21.4	21.4	21.5	24.3	24.3	24.3	24.4					
Hi PR	252	253	255	259	291	293	294	299	332	334	335	340	377	378	379	384	424	425	427	431	475	476	478	482					
Lo PR	120	122	125	130	127	129	132	137	134	135	138	143	139	140	143	148	144	145	148	153	151	152	155	160					
MBh	60.3	61.1	62.8	65.5	59.8	60.6	62.3	64.9	58.3	59.1	60.8	63.4	55.7	56.5	58.2	60.9	52.6	53.4	55.1	57.7	49.7	50.5	52.2	54.8					
S/T	1.00	0.89	0.75	0.6	1.00	0.89	0.76	0.6	1.00	0.92	0.78	0.6	1.00	0.94	0.80	0.7	1.00	1.00	0.82	0.7	1.00	1.00	0.88	0.7					
ΔT	25	23	20	16	25	23	20	16	25	23	20	16	25	23	20	16	25	23	19	16	26	24	21	17.0					
kW	3.25	3.25	3.24	3.3	3.66	3.66	3.65	3.7	4.11	4.11	4.10	4.1	4.60	4.59	4.59	4.6	5.14	5.14	5.13	5.2	5.78	5.78	5.77	5.8					
Amps	12.9	12.8	12.8	13.0	14.7	14.7	14.7	14.8	16.8	16.8	16.7	16.9	19.0	19.0	19.0	19.1	21.5	21.5	21.5	21.6	24.4	24.4	24.4	24.5					
Hi PR	255	256	257	262	294	295	297	301	335	336	338	342	379	380	382	386	427	428	429	434	477	478	480	484					
Lo PR	123	124	127	132	130	131	134	139	136	137	140	145	141	143	146	151	146	148	151	156	153	154	157	162					
85	AIRFLOW	59	63	67	71	59	63	67	71	59	63	67	71	59	63	67	71	59	63	67	71	59	63	67	71				
	MBh	59.5	60.3	62.1	64.7	59.0	59.8	61.6	64.2	57.5	58.3	60.1	62.7	54.9	55.8	57.5	60.1	51.8	52.6	54.3	56.9	48.9	49.7	51.4	54.1				
	S/T	1.00	0.94	0.81	0.7	1.00	0.95	0.81	0.7	1.00	1.00	0.84	0.7	1.00	1.00	0.86	0.7	1.00	1.00	0.88	0.7	1.00	1.00	0.93	0.8				
	ΔT	30	28	25	21	30	28	25	21	30	28	25	22	30	28	25	21	30	28	25	21	31	29	26	22.2				
	kW	3.23	3.23	3.22	3.3	3.64	3.63	3.63	3.7	4.09	4.08	4.08	4.1	4.57	4.57	4.56	4.6	5.12	5.12	5.11	5.1	5.76	5.75	5.75	5.8				
	Amps	12.8	12.7	12.7	12.9	14.6	14.6	14.6	14.7	16.7	16.7	16.6	16.8	18.9	18.9	18.9	19.0	21.4	21.4	21.3	21.5	24.3	24.3	24.3	24.4				
	Hi PR	252	253	255	259	291	292	294	298	332	333	335	339	376	377	379	384	424	425	427	431	475	476	478	482				
	Lo PR	121	122	125	130	128	129	132	137	134	136	138	143	139	141	144	149	145	146	149	154	151	152	155	160				
	MBh	60.2	61.0	62.7	65.3	59.6	60.4	62.2	64.8	58.1	58.9	60.7	63.3	55.6	56.4	58.1	60.7	52.4	53.2	54.9	57.5	49.5	50.3	52.0	54.7				
	S/T	1.00	0.97	0.83	0.7	1.00	0.98	0.84	0.7	1.00	1.00	0.87	0.7	1.00	1.00	0.89	0.7	1.00	1.00	0.91	0.8	1.00	1.00	0.96	0.8				
ΔT	29	28	24	21	29	28	24	21	30	28	24	21	29	28	24	21	29	27	24	20	30	28	25	21.5					
kW	3.25	3.24	3.24	3.3	3.65	3.65	3.64	3.7	4.10	4.10	4.09	4.1	4.59	4.58	4.58	4.6	5.13	5.13	5.12	5.2	5.77	5.77	5.76	5.8					
Amps	12.8	12.8	12.8	12.9	14.7	14.7	14.7	14.8	16.7	16.7	16.7	16.8	19.0	18.9	18.9	19.1	21.5	21.4	21.4	21.5	24.4	24.4	24.3	24.5					
Hi PR	253	255	256	261	293	294	295	300	334	335	336	341	378	379	381	385	425	427	428	433	476	477	479	483					
Lo PR	122	123	126	131	129	131	134	139	135	137	140	145	141	142	145	150	146	147	150	155	152	154	157	162					
MBh	61.3	62.1	63.8	66.4	60.8	61.6	63.3	65.9	59.3	60.1	61.8	64.4	56.7	57.5	59.2	61.8	53.5	54.3	56.1	58.7	50.6	51.5	53.2	55.8					
S/T	1.00	0.99	0.85	0.7	1.00	0.99	0.86	0.7	1.00	1.00	0.88	0.7	1.00	1.00	0.90	0.8	1.00	1.00	0.93	0.8	1.00	1.00	1.00	0.8					
ΔT	28	27	23	20	28	27	23	20	29	27	23	20	28	27	23	20	28	26	23	19	29	27	24	20.6					
kW	3.26	3.26	3.25	3.3	3.67	3.66	3.66	3.7	4.12	4.11	4.11	4.1	4.60	4.60	4.59	4.6	5.15	5.15	5.14	5.2	5.79	5.78	5.78	5.8					
Amps	12.9	12.9	12.9	13.0	14.7	14.7	14.7	14.8	16.8	16.8	16.8	16.9	19.0	19.0	19.0	19.1	21.5	21.5	21.5	21.6	24.5	24.4	24.4	24.6					
Hi PR	256	257	259	263	295	296	298	302	336	337	339	343	380	381	383	387	428	429	431	435	479	480	481	486					
Lo PR	124	126	129	134	131	133	136	141	138	139	142	147	143	144	147	152	148	150	152	157	155	156	159	164					

IDB: Entering Indoor Dry Bulb Temperature
 High and low pressures are measured at the liquid and suction service valves.
 Shaded area reflects AHRI conditions
 kW = Total system power
 Amps = outdoor unit amps (compressor + fan)

DZ18TC0241C* / CA*F3137*6A*+MBVC1200**-1A*+TX

100 % CAPACITY

	OUTDOOR AMBIENT TEMPERATURE																
	65	60	55	50	47	45	40	35	30	25	20	17	15	10	5	0	-5
MBh	29.04	27.35	25.69	24.06	23.00	22.23	20.37	18.54	17.07	15.99	15.22	14.80	14.25	12.89	11.52	10.15	8.79
T/R	30.24	28.76	27.28	25.80	24.91	24.13	22.06	20.10	18.48	17.31	16.48	16.03	15.44	13.96	12.48	10.99	9.51
KW	1.51	1.53	1.55	1.57	1.58	1.59	1.61	1.63	1.65	1.67	1.70	1.71	1.72	1.74	1.76	1.78	1.80
AMPS	5.2	5.3	5.4	5.5	5.5	5.6	5.7	5.7	5.8	5.9	6.0	6.1	6.1	6.2	6.3	6.4	6.5
COP	5.65	5.25	4.86	4.49	4.26	4.10	3.70	3.33	3.03	2.80	2.63	2.54	2.43	2.17	1.92	1.67	1.43
Hi PR	364	352	340	328	321	317	305	293	281	269	257	250	246	234	222	210	198
LO PR	147	138	129	120	114	111	102	92	83	74	65	59	56	47	37	28	19

Calculations are based on nominal CFM and 70 °F indoor dry bulb.

Amps = Outdoor unit amps (comp.+fan)

Note: Shaded area is AHRI Rating Conditions at 47°F outdoor ambient temperature

kW = Total system power

DZ18TC0361C*+CA*F3743*6D*+MBVC1600**-1A*+TXV

100 % CAPACITY

	OUTDOOR AMBIENT TEMPERATURE																
	65	60	55	50	47	45	40	35	30	25	20	17	15	10	5	0	-5
MBh	44.14	41.58	39.07	36.60	35.00	33.83	31.03	28.24	26.03	24.39	23.23	22.60	21.77	19.71	17.64	15.57	13.51
T/R	32.21	30.64	29.07	27.51	26.56	25.74	23.55	21.47	19.76	18.51	17.63	17.15	16.52	14.96	13.39	11.82	10.25
KW	2.78	2.74	2.70	2.67	2.64	2.63	2.59	2.55	2.52	2.48	2.44	2.42	2.40	2.36	2.33	2.29	2.25
AMPS	10.1	10.0	9.8	9.7	9.6	9.5	9.3	9.2	9.0	8.8	8.7	8.6	8.5	8.3	8.2	8.0	7.9
COP	4.65	4.45	4.23	4.02	3.88	3.77	3.51	3.24	3.03	2.89	2.79	2.74	2.66	2.44	2.22	1.99	1.76
Hi PR	418	404	390	377	369	363	350	336	323	309	295	287	282	268	255	241	227

Note: Shaded area is AHRI Rating Conditions at 47°F outdoor ambient temperature

kW = Total system power

DZ18TC0481C*+CA*F4961*6D*+MBVC2000**-1A*+TXV

100 % CAPACITY

	OUTDOOR AMBIENT TEMPERATURE																
	65	60	55	50	47	45	40	35	30	25	20	17	15	10	5	0	-5
MBh	67.74	63.10	58.87	54.06	51.00	48.58	42.62	37.28	32.94	29.66	27.15	25.80	24.12	19.92	15.72	11.52	7.32
T/R	34.99	32.76	30.54	28.32	26.99	25.70	22.55	19.72	17.43	15.69	14.36	13.65	12.76	10.54	8.32	6.09	3.87
KW	4.83	4.64	4.45	4.26	4.15	4.08	3.89	3.70	3.51	3.33	3.14	3.02	2.95	2.76	2.57	2.39	2.20
AMPS	18.2	17.4	16.6	15.8	15.3	14.9	14.1	13.3	12.5	11.7	10.9	10.4	10.0	9.2	8.4	7.6	6.8
LO PR	140	131	123	114	109	105	96	88	79	70	62	56	53	44	35	27	18

Calculations are based on nominal CFM and 70 °F indoor dry bulb.

Amps = Outdoor unit amps (comp.+fan)

Note: Shaded area is AHRI Rating Conditions at 47°F outdoor ambient temperature

kW = Total system power

DZ18TC0601C*+CA*F4961*6D*+MBVC2000**-1A*+TXV

100 % CAPACITY

	OUTDOOR AMBIENT TEMPERATURE																
	65	60	55	50	47	45	40	35	30	25	20	17	15	10	5	0	-5
MBh	77.42	72.40	67.46	62.61	59.50	57.20	51.36	45.97	41.58	38.31	35.90	34.60	32.94	28.79	24.64	20.49	16.34
T/R	37.46	35.37	33.29	31.20	29.94	28.78	25.84	23.13	20.92	19.28	18.06	17.41	16.58	14.49	12.40	10.31	8.22
KW	5.11	5.03	4.96	4.89	4.84	4.82	4.74	4.67	4.60	4.52	4.45	4.41	4.38	4.31	4.23	4.16	4.09
AMPS	19.3	19.0	18.6	18.3	18.1	18.0	17.7	17.4	17.1	16.8	16.4	16.2	16.1	15.8	15.5	15.2	14.9
COP	4.44	4.22	3.99	3.75	3.60	3.48	3.17	2.89	2.65	2.48	2.36	2.30	2.20	1.96	1.71	1.44	1.17
Hi PR	459	444	429	414	405	399	384	369	354	339	324	315	310	295	280	265	250
LO PR	134	126	117	109	104	101	92	84	76	67	59	54	51	42	34	26	17

Calculations are based on nominal CFM and 70 °F indoor dry bulb.

Amps = Outdoor unit amps (comp.+fan)

Note: Shaded area is AHRI Rating Conditions at 47°F outdoor ambient temperature

kW = Total system power

DZ18TC0241C* / CA*F3137*6A*+MBVC1200**-1A*+TX

70% CAPACITY

	OUTDOOR AMBIENT TEMPERATURE																
	65	60	55	50	47	45	40	35	30	25	20	17	15	10	5	0	-5
MBh	21.71	20.28	18.87	17.48	16.59	15.93	14.25	12.71	11.45	10.52	9.82	9.45	8.97	7.78	6.59	5.40	4.21
T/R	43.15	40.69	38.23	35.77	34.29	32.92	29.45	26.27	23.67	21.74	20.30	19.53	18.54	16.08	13.62	11.16	8.70
KW	0.94	0.93	0.93	0.92	0.91	0.91	0.90	0.90	0.89	0.88	0.88	0.87	0.87	0.86	0.86	0.85	0.84
AMPS	3.4	3.3	3.3	3.3	3.3	3.3	3.2	3.2	3.2	3.1	3.1	3.1	3.1	3.0	3.0	3.0	2.9
COP	6.77	6.37	5.98	5.58	5.32	5.12	4.62	4.15	3.77	3.49	3.28	3.18	3.02	2.64	2.26	1.87	1.47
Hi PR	353	341	330	318	311	307	295	284	272	261	249	243	238	226	215	204	192
LO PR	145	136	127	118	112	109	100	91	82	73	64	58	55	46	37	28	19

Calculations are based on nominal CFM and 70 °F indoor dry bulb.

Amps = Outdoor unit amps (comp.+fan)

Note: Shaded area is AHRI Rating Conditions at 47°F outdoor ambient temperature

kW = Total system power

DZ18TC0361C*+CA*F3743*6D*+MBVC1600**-1A*+TXV

70% CAPACITY

	OUTDOOR AMBIENT TEMPERATURE																
	65	60	55	50	47	45	40	35	30	25	20	17	15	10	5	0	-5
MBh	33.01	30.84	28.70	26.59	25.25	24.24	21.70	19.37	17.47	16.05	14.99	14.43	13.71	11.90	10.10	8.30	6.49
T/R	34.58	32.61	30.65	28.69	27.51	26.41	23.64	21.10	19.03	17.48	16.33	15.72	14.93	12.97	11.00	9.04	7.07
KW	1.70	1.65	1.61	1.56	1.53	1.51	1.46	1.41	1.36	1.31	1.26	1.23	1.22	1.17	1.12	1.07	1.02
AMPS	6.1	5.8	5.6	5.4	5.3	5.2	5.0	4.8	4.6	4.4	4.1	4.0	3.9	3.7	3.5	3.3	3.1
COP	5.68	5.46	5.24	5.01	4.85	4.71	4.36	4.03	3.76	3.58	3.48	3.43	3.31	2.99	2.65	2.28	1.87
Hi PR	405	392	378	365	357	352	339	326	313	299	286	278	273	260	247	234	220

Note: Shaded area is AHRI Rating Conditions at 47°F outdoor ambient temperature

kW = Total system power

DZ18TC0481C*+CA*F4961*6D*+MBVC2000**-1A*+TXV

70% CAPACITY

	OUTDOOR AMBIENT TEMPERATURE																
	65	60	55	50	47	45	40	35	30	25	20	17	15	10	5	0	-5
MBh	48.87	45.52	42.52	39.08	36.79	34.79	29.97	25.71	22.26	19.63	17.57	16.47	15.12	11.73	8.34	4.96	1.57
T/R	39.35	36.65	33.99	31.26	29.62	28.01	24.13	20.70	17.93	15.80	14.15	13.26	12.17	9.44	6.72	3.99	1.26
KW	2.91	2.77	2.63	2.48	2.40	2.34	2.20	2.06	1.91	1.77	1.63	1.54	1.49	1.35	1.20	1.06	0.92
AMPS	10.8	10.2	9.6	9.0	8.6	8.4	7.7	7.1	6.5	5.9	5.3	4.9	4.6	4.0	3.4	2.8	2.2
LO PR	137	129	120	112	107	103	95	86	78	69	61	55	52	43	35	26	18

Calculations are based on nominal CFM and 70 °F indoor dry bulb.

Amps = Outdoor unit amps (comp.+fan)

Note: Shaded area is AHRI Rating Conditions at 47°F outdoor ambient temperature

kW = Total system power

DZ18TC0601C*+CA*F4961*6D*+MBVC2000**-1A*+TXV

70% CAPACITY

	OUTDOOR AMBIENT TEMPERATURE																
	65	60	55	50	47	45	40	35	30	25	20	17	15	10	5	0	-5
MBh	57.01	53.11	49.45	45.46	42.92	40.93	36.01	31.58	27.98	25.27	23.20	22.09	20.70	17.23	13.76	10.28	6.81
T/R	42.77	40.09	37.41	34.73	33.12	31.58	27.78	24.37	21.59	19.50	17.90	17.04	15.97	13.29	10.61	7.93	5.25
KW	3.13	3.04	2.94	2.85	2.80	2.76	2.67	2.58	2.49	2.40	2.31	2.25	2.22	2.12	2.03	1.94	1.85
AMPS	11.7	11.3	10.9	10.5	10.3	10.1	9.7	9.3	8.9	8.5	8.1	7.9	7.7	7.3	6.9	6.5	6.1
COP	5.34	5.13	4.92	4.67	4.50	4.34	3.95	3.59	3.30	3.09	2.95	2.88	2.74	2.38	1.98	1.55	1.08
Hi PR	445	430	416	401	392	387	372	358	343	329	314	306	300	285	271	257	242
LO PR	132	124	115	107	102	99	91	83	74	66	58	53	50	42	33	25	17

Calculations are based on nominal CFM and 70 °F indoor dry bulb.

Amps = Outdoor unit amps (comp.+fan)

Note: Shaded area is AHRI Rating Conditions at 47°F outdoor ambient temperature

kW = Total system power

***ALL AHRI SYSTEM RATINGS ARE ACCESSIBLE IN THE UNITARY MATCHUP TOOL VIA
DAIKIN CITY OR IN THE DAIKIN SYSTEM CONFIGURATOR TOOL VIA PARTNERLINK.***

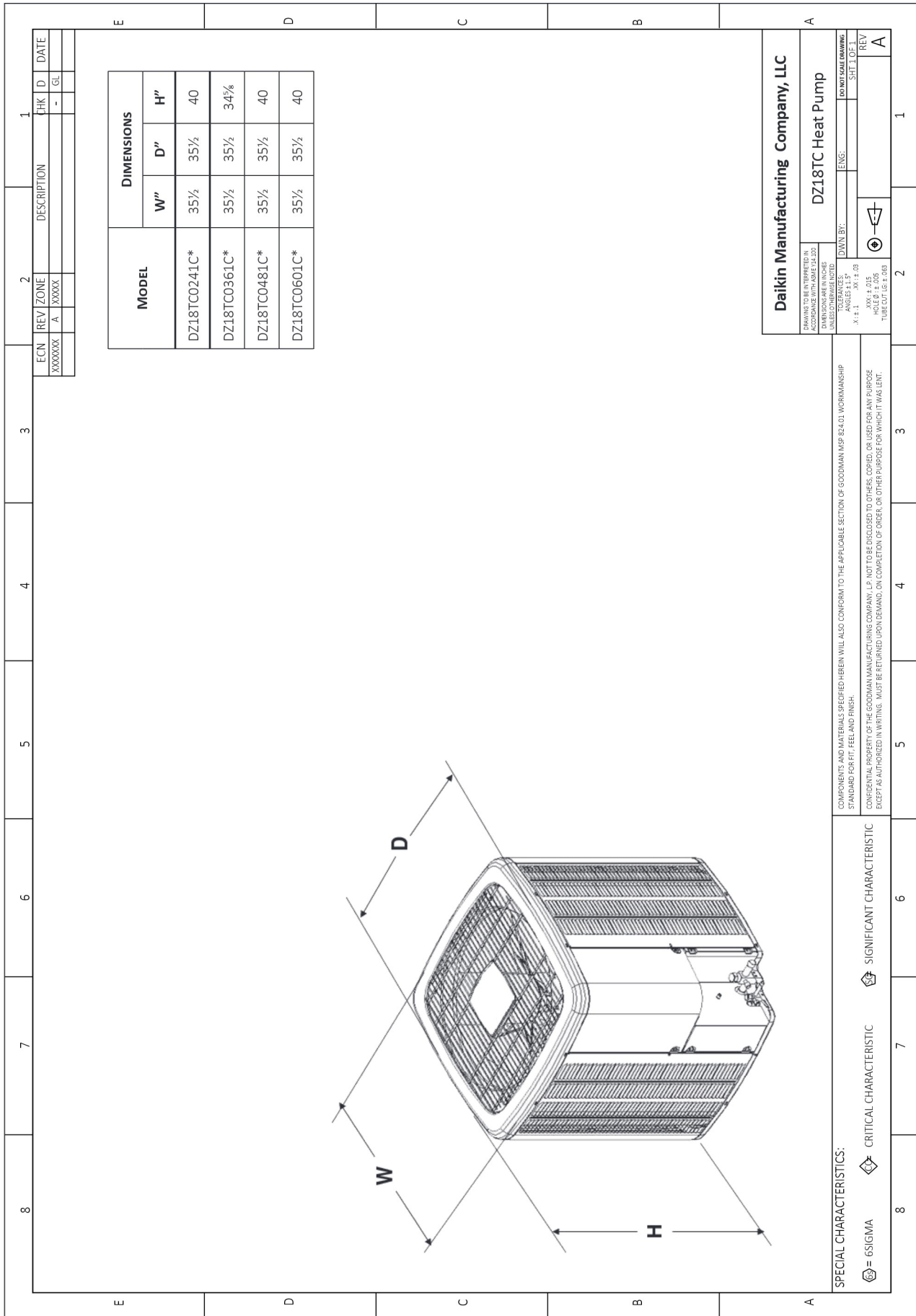

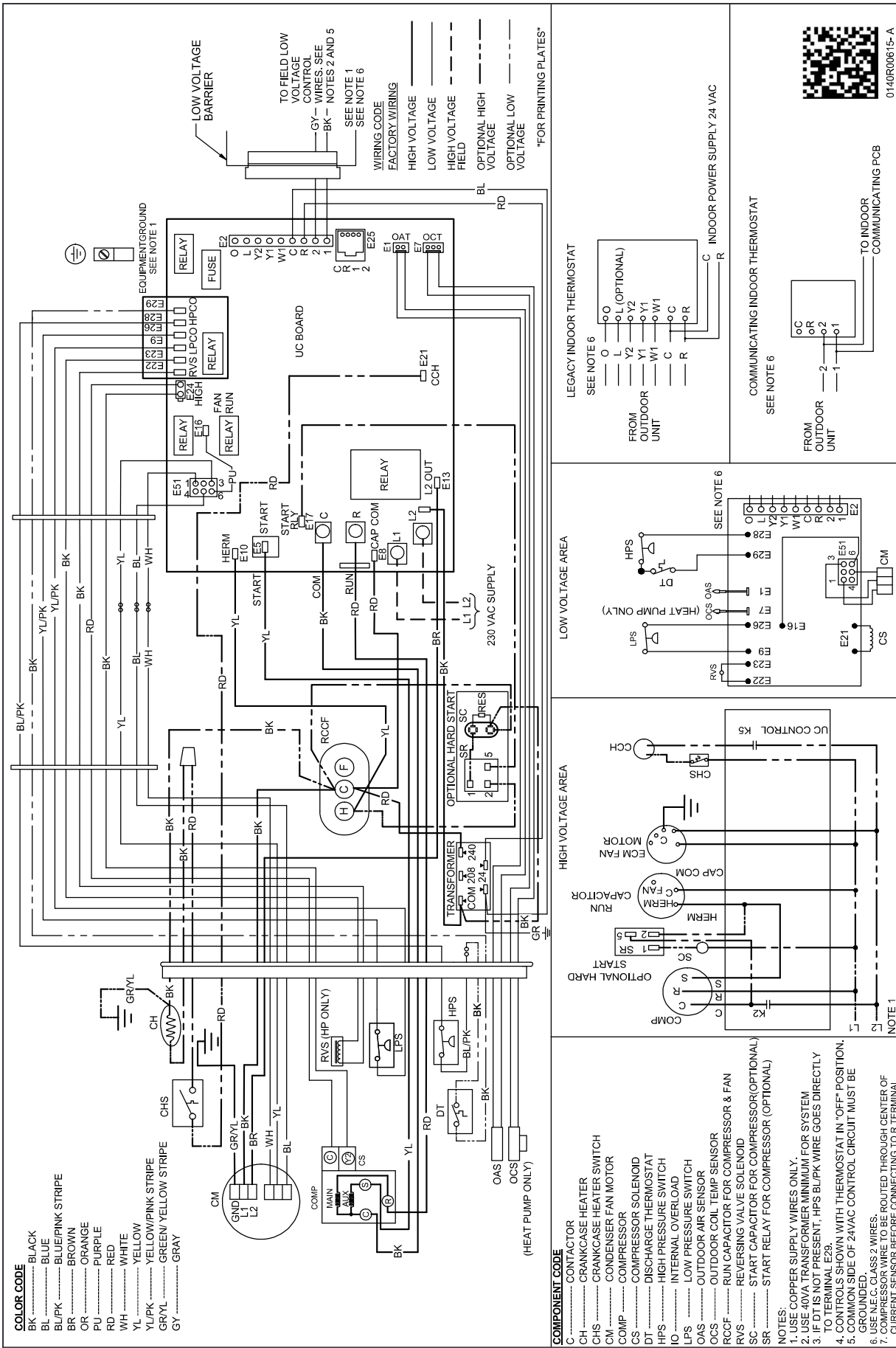

WARNING

High Voltage: Disconnect all power before servicing or installing this unit. Multiple power sources may be present. Failure to do so may cause property damage, personal injury, or death.

Wiring is subject to change. Always refer to the wiring diagram on the unit for the most up-to-date wiring.

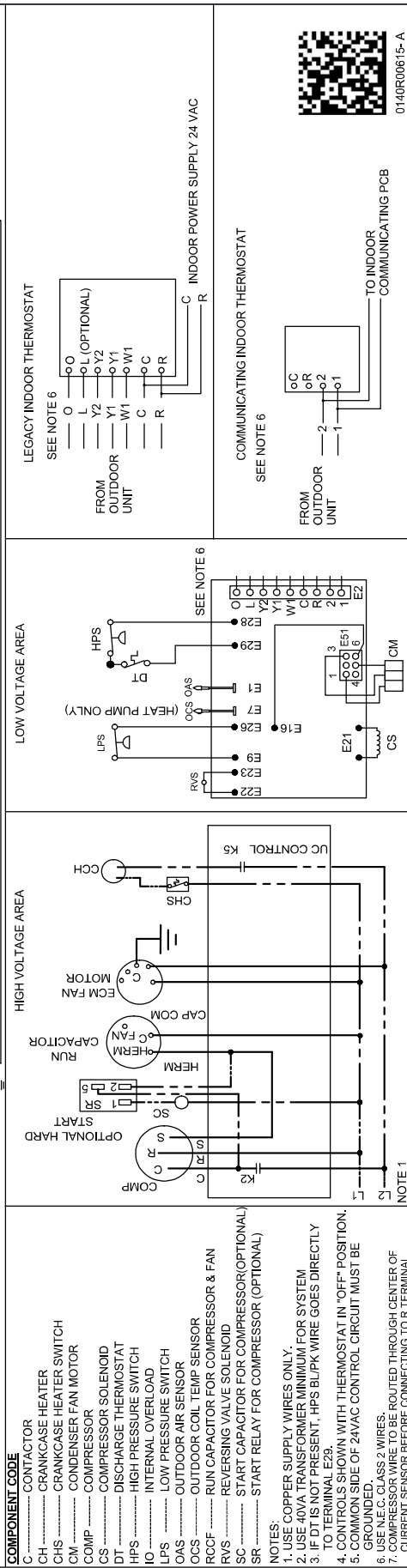

0140R00615-A

MODEL	DESCRIPTION	DZ18TC 24**	DZ18TC 036**	DZ18TC 048**	DZ18TC 060**
ABK-20	Anchor Bracket Kit ⁰	X	X	X	X
CSR-U-1	Hard-start Kit	X	X		
CSR-U-2	Hard-start Kit		X	X	X
CSR-U-3	Hard-start Kit			X	X
FSK01A ²	Freeze Protection Kit	X	X	X	X
OT18-60A ³	Outdoor Thermostat/Lockout Thermostat	X	X	X	X
TX2N4 ⁴	TXV Kit	X			
TX3N4 ⁴	TXV Kit		X		
TX5N4 ⁴	TXV Kit			X	X

⁰ Contains 20 brackets; four brackets needed to anchor unit to pad

¹ Available in 24V legacy mode only. This feature is integrated in the communicating mode.

² Installed on indoor coil

³ Available in 24V legacy mode only. This feature is integrated in the communicating mode. Required for heat pump applications where ambient temperature falls below 0 °F with 50% or higher relative humidity.

⁴ Condensing units and heat pumps with reciprocating compressors require the use of start-assist components when used in conjunction with an indoor coil using a non-bleed thermal expansion valve refrigerant metering device or liquid line solenoid kit. The TXV should always be sized based on the tonnage of the outdoor unit.

