

Whirlpool®

SERVICE MANUAL

WHIRLPOOL 2.8 CU FT SMART ALL-IN-ONE WASHER & DRYER



WFC8090GX

W11243198

FORWARD

This Whirlpool Service Manual, (Part No. W11243198), provides the In-Home Service Professional with service information for the “WHIRLPOOL 2.8 CU FT SMART ALL-IN-ONE WASHER & DRYER.”

The Wiring Diagram used in this Service Manual is typical and should be used for training purposes only. Always use the Wiring Diagram supplied with the product tech sheet when servicing the washer.

For specific operating and installation information on the model being serviced, refer to the “Use and Care Guide” or “Installation Instructions” provided with the washer.

GOALS AND OBJECTIVES

The goal of this Service Manual is to provide information that will enable the In-Home Service Professional to properly diagnose malfunctions and repair the “WHIRLPOOL SMART ALL-IN-ONE WASHER & DRYER.”

The objectives of this Service Manual are to:

- Understand and follow proper safety precautions.
- Successfully troubleshoot and diagnose malfunctions.
- Successfully perform necessary repairs.
- Successfully return the washer to its proper operational status.

WHIRLPOOL CORPORATION assumes no responsibility for any repairs made on our products by anyone other than authorized In-Home Service Professionals.

TABLE OF CONTENTS

WHIRLPOOL SMART ALL-IN-ONE WASHER & DRYER

SECTION 1 — GENERAL INFORMATION

WASHER/DRYER SAFETY	1-2
INTRODUCTION	1-3
CONTROL PANEL AND FEATURES	1-4
CONTROL PANEL - TOOLS	1-5
LOAD & GO BULK DISPENSER.....	1-5
THEORY OF OPERATION	1-6
PRODUCT SPECIFICATIONS	1-7
WIRING DIAGRAM LOCATION.....	1-8
MODEL AND SERIAL NUMBER LOCATION.....	1-8
MODEL AND SERIAL NUMBER NOMENCLATURE	1-9
ALL-IN-ONE WASHER/DRYER MAINTENANCE	1-10
CLEANING THE DRAIN PUMP FILTER/DRAINING RESIDUAL WATER.....	1-12
HOW TO MANUALLY OPEN A LOCKED DOOR	1-13

SECTION 2 — DIAGNOSTICS & TROUBLESHOOTING

CONTROL PANEL.....	2-2
ABBREVIATIONS	2-3
DIAGNOSTIC GUIDE.....	2-3
SERVICE DIAGNOSTIC MODE	2-3
ACTIVATING SERVICE DIAGNOSTIC MODE	2-3
SERVICE DIAGNOSTIC MODE TESTS.....	2-3
FAULT/ERROR CODES.....	2-7
TROUBLESHOOTING GUIDE	2-9

SECTION 3 — COMPONENT TESTING

COMPONENT TESTING: SAFETY INFORMATION.....	3-2
WIRING DIAGRAM.....	3-3
COMPONENT TESTING	3-4
TEST #1: ACU POWER CHECK.....	3-4
APPLIANCE CONTROL UNIT & PINOUTS	3-5
TEST #2: HUMAN-MACHINE INTERFACE (HMI).....	3-6
TEST #3: MOTOR CIRCUIT	3-7
TEST #4: DOOR LOCK SYSTEM	3-8
TEST #5: INLET VALVE	3-9
TEST #6: PRESSURE SWITCH	3-10
TEST #7: DRAIN/RECIRCULATION PUMP.....	3-11
TEST #8: WASH HEATING ELEMENT.....	3-12
TEST #9: WASH TEMPERATURE SENSOR	3-13
TEST #10A: DISPENSER SENSING.....	3-14
TEST #10B: DISPENSER METERING PUMPS.....	3-16
TEST #11: SUPPLY CONNECTIONS - US	3-17
TEST #11: SUPPLY CONNECTIONS - CAN.....	3-18
TEST #12A: DRY HEATING ELEMENT.....	3-19
TEST #12B: DRY TEMPERATURE SENSOR (NTC).....	3-20
TEST #13: DRY FAN MOTOR	3-21

Continued on next page . . .

TABLE OF CONTENTS (CONT.)

WHIRLPOOL SMART ALL-IN-ONE WASHER & DRYER

SECTION 4 — COMPONENT ACCESS

REMOVING THE DOOR ASSEMBLY	4-2
REMOVING THE TOP PANEL	4-3
REPLACING THE HUMAN-MACHINE INTERFACE	4-4
REMOVING THE FRONT PANEL & BULKHEAD	4-6
REMOVING THE REAR ACCESS PANEL.....	4-7
REMOVING THE INLET VALVE ASSEMBLY	4-8
REMOVING THE PRESSURE SWITCH	4-9
REMOVING THE METERING PUMPS	4-10
REMOVING THE DETERGENT DISPENSER	4-11
REMOVING THE DRYER HEATING CHANNEL ASSEMBLY	4-12
REMOVING THE CONDENSER DUCT ASSEMBLY	4-13
REMOVING THE RFI FILTER	4-14
REMOVING THE DOOR LOCK ASSEMBLY	4-15
REMOVING THE APPLIANCE CONTROL UNIT (ACU)	4-16
REMOVING THE MOTOR CONTROL UNIT (MCU).....	4-17
REMOVING THE HEATER & THERMISTOR	4-18
REMOVING THE DRAIN & RECIRCULATION PUMPS	4-19
REMOVING THE DIRECT DRIVE MOTOR	4-20
REMOVING THE TUB ASSEMBLY	4-22

SECTION 5 — CONNECTIVITY

SMART FEATURES	5-2
INTERNET CONNECTIVITY GUIDE.....	5-3
WPS CONNECTIVITY INSTRUCTIONS	5-4
SMART OPERATION	5-5
CONNECTIVITY TROUBLESHOOTING	5-6

PRODUCT SPECIFICATIONS & WARRANTY INFORMATION SOURCES (inside back cover)

Section 1: General Information

This section provides general safety, parts, and information for the “Whirlpool Smart All-In-One Washer & Dryer.”

- Washer & Dryer Safety
- General Information
- Control Panel and Features
- Load & Go Bulk Dispenser
- Theory of Operation
- Product Specifications
- Wiring Diagram Location
- Model & Serial Number Location
- Model & Serial Number Nomenclature
- All-In-One Washer/Dryer Maintenance
- Cleaning the Drain Pump Filter/Draining Residual Water
- How to Manually Open a Locked Door
- Notes

Washer & Dryer Safety

Your safety and the safety of others are very important.

We have provided many important safety messages in this manual and on your appliance. Always read and obey all safety messages.



This is the safety alert symbol.

This symbol alerts you to potential hazards that can kill or hurt you and others.

All safety messages will follow the safety alert symbol and either the word "DANGER" or "WARNING."

These words mean:

⚠ DANGER

You can be killed or seriously injured if you don't immediately follow instructions.

⚠ WARNING

You can be killed or seriously injured if you don't follow instructions.

All safety messages will tell you what the potential hazard is, tell you how to reduce the chance of injury, and tell you what can happen if the instructions are not followed.

General Information

INTRODUCTION

Reinvent your laundry routine with a washer and dryer in one machine. Innovative features on the Smart All-In-One Washer & Dryer help you do laundry in fewer steps. Compact 24" width and ventless, flexible enough to virtually install anywhere. Never switch clothes to a dryer again, plus skip steps with innovative features like Load & Go™ dispenser and Automatic Lint removal.



Smart All-In-One Washer & Dryer

Features:

- Load & Go™ Plus Dispenser: (see page 1-4)
- Space-Saving Design:
- Smart Appliance:

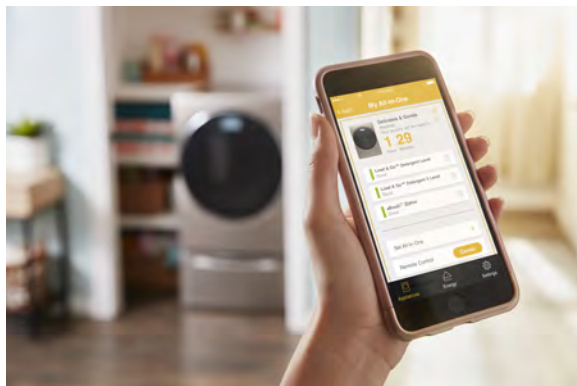

Smart Appliance with Remote Control

What/How Controls:

This washer/dryer has a unique user interface to help you select the best wash cycle for your load. The "What to Wash/How to Wash" layout guides you to the optimal cycle in two easy steps:

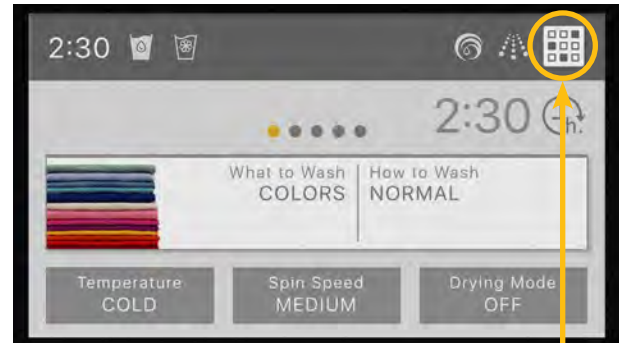

What to Wash & How to Wash



Soil Level Option

The Soil Level option allows you to select a Light, Normal, or Heavy soil level setting. The recommended soil level is preset for each cycle. Some preset soil levels can be changed. For heavily soiled and sturdy fabrics, select the Heavy soil level setting. For lightly soiled and delicate fabrics, select the Light soil level setting. Lower soil level settings will help reduce tangling and wrinkling.

Extra Rinses Option

The Extra Rinses option provides one or more additional rinses to the selected cycle. The extra rinses can be canceled at any time by touching the "X" on the touch screen to the right of the estimated time remaining.

Pre-Soak Option

The Pre-Soak option can be set either on or off. Pre-Soak may be ended at any time by touching the "X" on the touch screen to the right of the estimated time remaining.

TumbleFresh™ Option:

The Tumble Fresh™ option will periodically tumble the load after the end of the cycle for up to 12 hours. Touch TUMBLE FRESH to activate this option. This option is not available when a drying mode is selected. Tumble Fresh™ may be ended at any time by touching the "X" on the touch screen to the right of the estimated time remaining.

Wrinkle Shield™ Option:

The Wrinkle Shield™ option is only available when a drying mode is selected, and will periodically tumble the load after the end of the cycle for up to 12 hours. Wrinkle Shield™ may be ended at any time by touching the "X" on the touch screen to the right of the estimated time remaining.

Accessories:

Pedestal with Storage: WFP2411GX

Color-matched pedestals raise the washer/dryer to a more comfortable working height.

Control Panel and Features

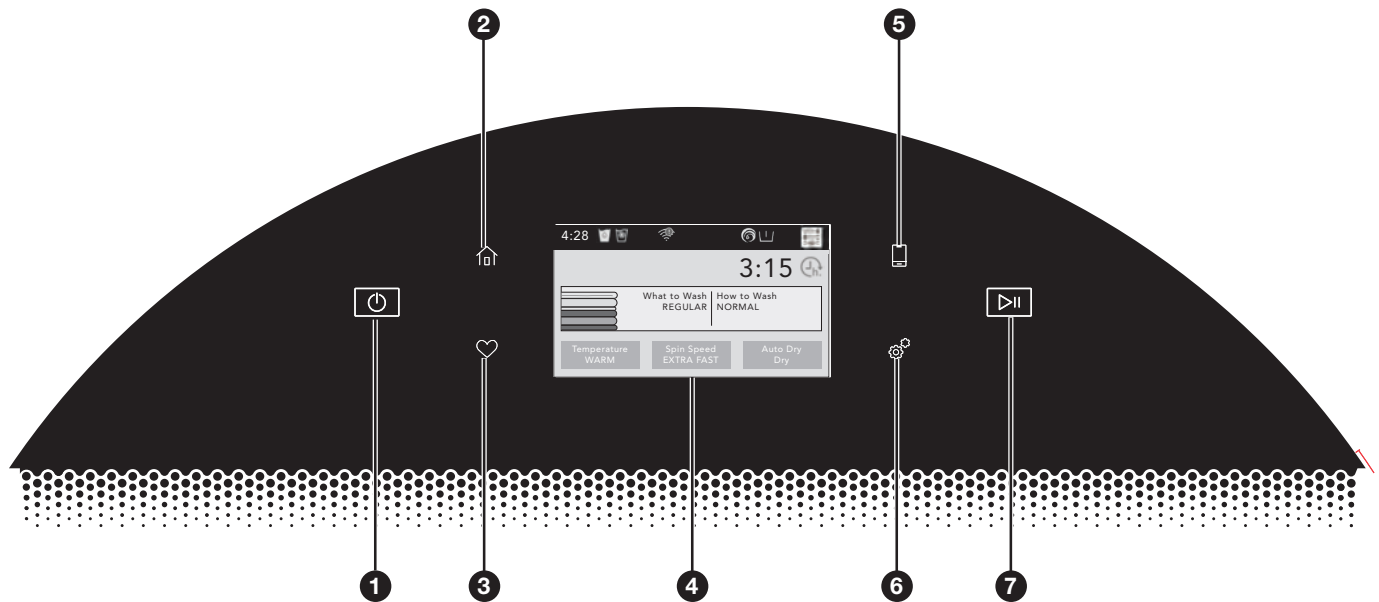

- 1 POWER BUTTON**
Touch to power up the washer/dryer.
- 2 HOME BUTTON**
Touch this button and the LCD screen will show the home screen, where you can select your cycle, settings, and options.
- 3 FAVORITES BUTTON**
Stores and accesses your favorite cycles.
- 4 LCD SCREEN**
Use this screen to select cycle, settings, options, etc.
- 5 REMOTE ENABLE BUTTON**
Touch this button to be able to use the Whirlpool™ app to control the washer/dryer. Download the Whirlpool™ app and follow the instructions to connect your washer/dryer to your home Wi-Fi network. You may also visit www.whirlpool.com/connect. In Canada, visit www.whirlpool.ca/en_CA and click on the Whirlpool® Connected Appliances link.
- 6 TOOLS BUTTON**
Touch this button to access the tools screen. For more information, see page 13.
- 7 START/PAUSE BUTTON**
Touch to start, or touch to pause a cycle. When you start a cycle, the door will lock, the washer/dryer will sense the load size, and the wash or dry cycle will begin.

Load & Go™ Bulk Dispenser

The Load & Go™ bulk dispenser holds up to 33.8 oz. (1000 mL) of liquid HE detergent (Dispenser 1) and 16.9 oz. (500 mL) of liquid fabric softener or liquid HE detergent (Dispenser 2), enough for multiple loads of laundry. It adds the appropriate quantity of HE detergent and liquid fabric softener to the wash load at the proper time. See “Using the Bulk Dispenser” for information on using the dispenser.



- A Dispenser 1**
This dispenser holds 33.8 oz (1000 mL) of liquid HE detergent for your main wash cycle, and automatically dispenses liquid detergent at the optimum time in the cycle.
- B Dispenser 2**
This dispenser holds 16.9 oz (500 mL) of liquid fabric softener. It automatically dispenses liquid fabric softener at the optimum time in the cycle. This dispenser may instead be used as a second liquid HE detergent dispenser. See Step 11 on page 13 for information.

IMPORTANT: Do not use chlorine bleach in this washer/dryer, and do not use powdered detergent in the Load & Go™ bulk dispenser. Powdered detergent must be added to the drum prior to adding laundry. See “Using the All-In-One Washer/Dryer.”

Control Panel - Tools

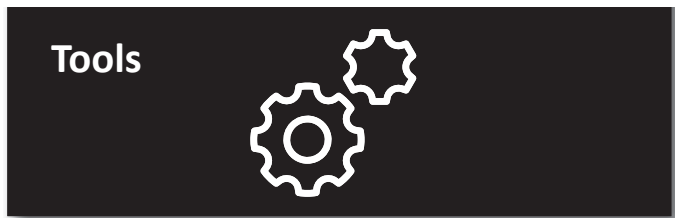

The Tools button gives access to many other settings, utility cycles, preferences, and information. Touch the TOOLS button to access the Tools screen, which contains the following (you will need to scroll down with your finger to access all of the selections).

Load & Go™ Dispenser 1

Press this icon to access:

Load & Go™ Status Dispenser 1 and choose between:

- Active
- Disabled (1 Cycle)
- Off (Permanently)

Detergent Concentration Dispenser 1 and choose between:

- 2X
- 4X
- 6X
- 8X

Load & Go™ Dispenser 2

Press this icon to access:

Load & Go™ Status Dispenser 2 and choose between:

- Active
- Disabled (1 Cycle)
- Off (Permanently)

Load & Go™ Content Dispenser 2 and choose between:

- Softener
- Detergent

Once set at Detergent:

Set Concentration Dispenser 2 and choose between:

- 2X
- 4X
- 6X
- 8X

Control Lock

Press this icon to lock the controls. Swipe up to unlock.

Mute

Press this icon to mute or unmute sounds.

Utility Cycles

Press this icon to access the following utility cycles: Spin, Drain, Rinse & Spin, and Clean Washer with affresh® cycle. Touch the utility cycle you wish to use and follow the screen prompts.

Preferences

Press to access Times and Dates, Sound Volume, Display Settings, and Regional. Follow the screen prompts.



WiFi

Press to access Connect to Network, SAID Codes, Mac Address, and WiFi. Follow the screen prompts.

Info

Press to access Service & Support, Store Demo Mode, Restore Factory, WiFi Terms and Conditions, and Software Terms and Conditions. Follow the screen prompts.

Load & Go Bulk Dispenser

Follow the steps below to fill the Load & Go™ bulk dispenser when using the washer for the first time, or when the low detergent icon  or low fabric softener icon  on the display indicate that the detergent or fabric softener level is running low.

1. Open the bulk container lid on the top of the washer/dryer.

2. Lift the fill door on the Liquid Detergent dispenser (Dispenser 1). Add liquid HE detergent up to the "MAX" line. Do not overfill. Close the fill door. It will click into place.

NOTE: If Dispenser 1 is empty, you may choose to add only enough liquid HE detergent for one load.



3. Lift the fill door on the Liquid Fabric Softener dispenser (Dispenser 2). Add liquid fabric softener up to the "MAX" line. Do not overfill. Close the fill door. It will click into place.

NOTE: If Dispenser 2 is empty, you may choose to add only enough liquid fabric softener for one load.



4. Slowly close the bulk container lid. Make sure it is completely closed.

5. Make sure that the bulk dispenser is active. Use the Tools button to make sure that both Dispenser 1 and Dispenser 2 are active and that the detergent concentration is correct.



Use only High Efficiency (HE) detergent.

NOTES:

- Dispenser 2 may be used as a second Liquid HE Detergent dispenser. Use the Tools button (go to "Load & Go™ Dispenser 2") to change the content in Dispenser 2 and set the detergent concentration. Make sure that the other dispenser is disabled.
- The entire Load & Go™ bulk container can be easily removed for ease of cleaning.
- Thoroughly clean the Liquid Detergent dispenser (Dispenser 1) before switching to a different brand of detergent.
- Thoroughly clean the Liquid Fabric Softener dispenser (Dispenser 2) before switching from liquid fabric softener to liquid detergent, before switching back from liquid detergent to liquid fabric softener, or before switching to a different brand of detergent.

IMPORTANT:

- Do not use chlorine bleach in this washer/dryer. Chlorine bleach will damage it.
- Do not add a single-dose laundry packet to the bulk dispenser.
- Do not use powdered HE detergent in the bulk dispenser.



Theory of Operation

Dry Cycle - Theory of Operation

The illustration below gives a brief description of the components involved specifically on a Dry Cycle. Knowledge on the system's physical parts is needed in order to properly diagnose and troubleshoot the "all-in-one" washer/dryer.

- 1. Blower** - Generates process air flow through the heater channel, tub, and condenser duct.
- 2. Air Heater** - Heats the air so it gets into the tub at high temperature and reduced relative humidity.
- 3. Heater Channel** - Conducts hot process air into the tub, so it can remove humidity from the laundry.
- 4. Inlet Air NTC** - Used as a feedback for the air heater Control Software.
- 5. Drain Pump** - Pumps out condensed humidity and cooling valve water that accumulates in the sump.
- 6. Sump NTC** - Used as a feedback for the Auto-Dry Cycle termination algorithms (apart from being used in heated wash cycles).
- 7. Condenser Duct** - Process air goes through condenser duct to "get dry" - humidity is condensed and drained out of the "all-in-one" washer/dryer.
- 8. Cooling Valve** - Used to spray water into the condenser duct, to cool down the process air and condense humidity.

Dry Cycle - Illustration

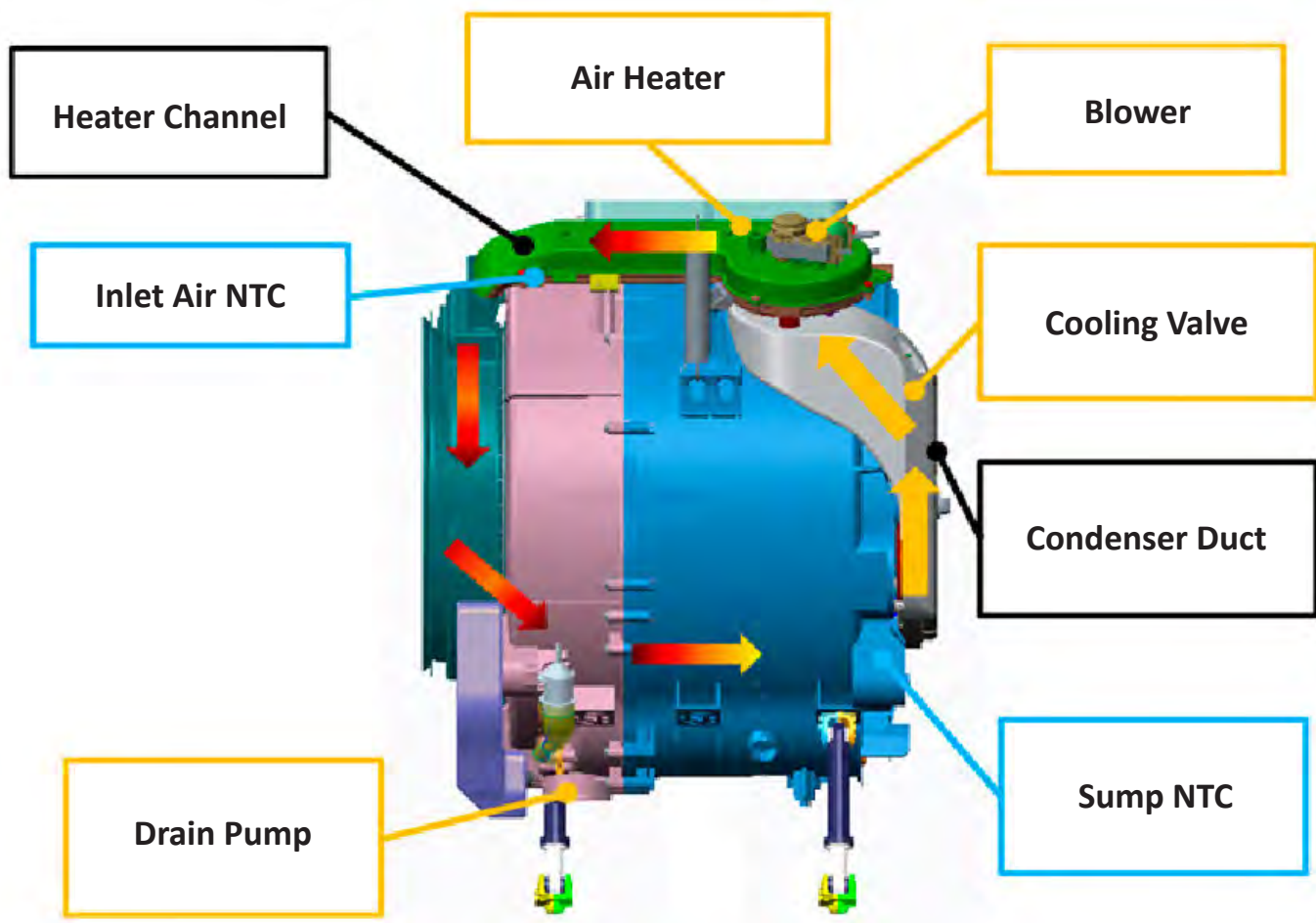

Figure 1 - Dry Cycle Theory of Operation

Product Specifications

UTILITIES	
Line Voltage :	240 VAC
Frequency :	60 Hz
Amps :	30A
Water Supply :	20-100 psi (137.9–689.6 kPa)
DETAILS	
Capacity :	WFC8090GX = 2.8 Cu Ft
Size :	24" Wide
Motor Drive Type :	Direct Drive
Motor Horsepower :	1/2 HP
Interior Light :	Yes
Drum Material :	Stainless Steel
Control :	Electronic - Digital Display
FEATURES	
Automatic Load Size Sensing :	Yes
Dispense System :	Detergent / Fabric Softener / Load & Go
Wash Cycles :	Clean Washer with affresh, Drain What to Wash - Regular, Colors, Whites, Towels, Delicates, Bulky Items How to Wash - Normal, Cold Wash, Heavy Duty, Quick, Sanitize, Rinse & Spin, Spin
Wash/Rinse Temperatures :	(5) Cold, Cool, Extra Hot, Hot, Warm
Spin :	5 Speeds, Maximum Speed - 1400
Dryer Cycles :	(2) Automatic Dry, Timed Dry
Automatic Lint Removal :	Yes
SMART Appliance :	Yes
Remote Start :	Yes
OPTIONS	
Washer Option Selections :	Cold Water Pre Wash for Stains Extra Rinse Tumble Fresh™ Wrinkle Shield™
DIMENSIONS	
Depth :	28" (71 cm)
Height :	33.75" (85.8 cm)
Width :	24" (61 cm)
Net Weight :	200 lbs. (90.7 kg)
ACCESSORIES	
Pedestal, 11.3" :	WFP2411GX

Wiring Diagram & Model/Serial Number Location



Figure - Wiring Diagram, Model/Serial Number Location

Model & Serial Number Nomenclature

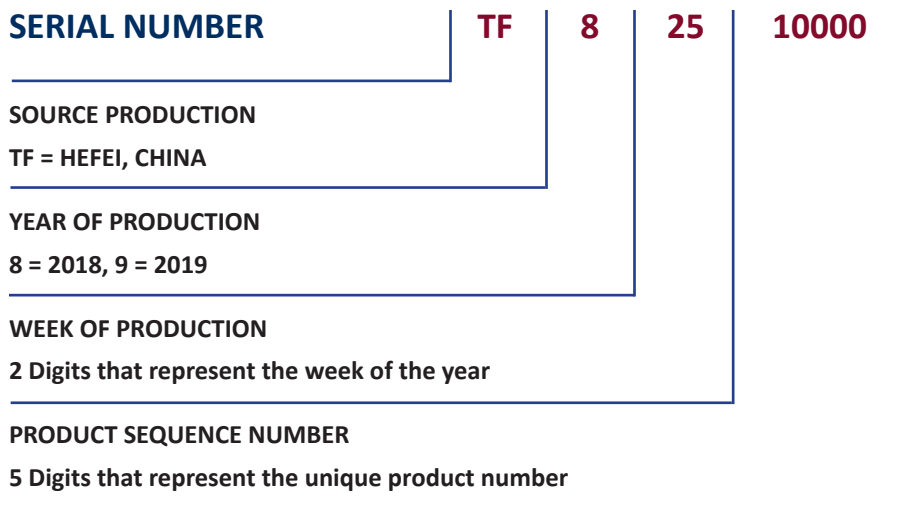
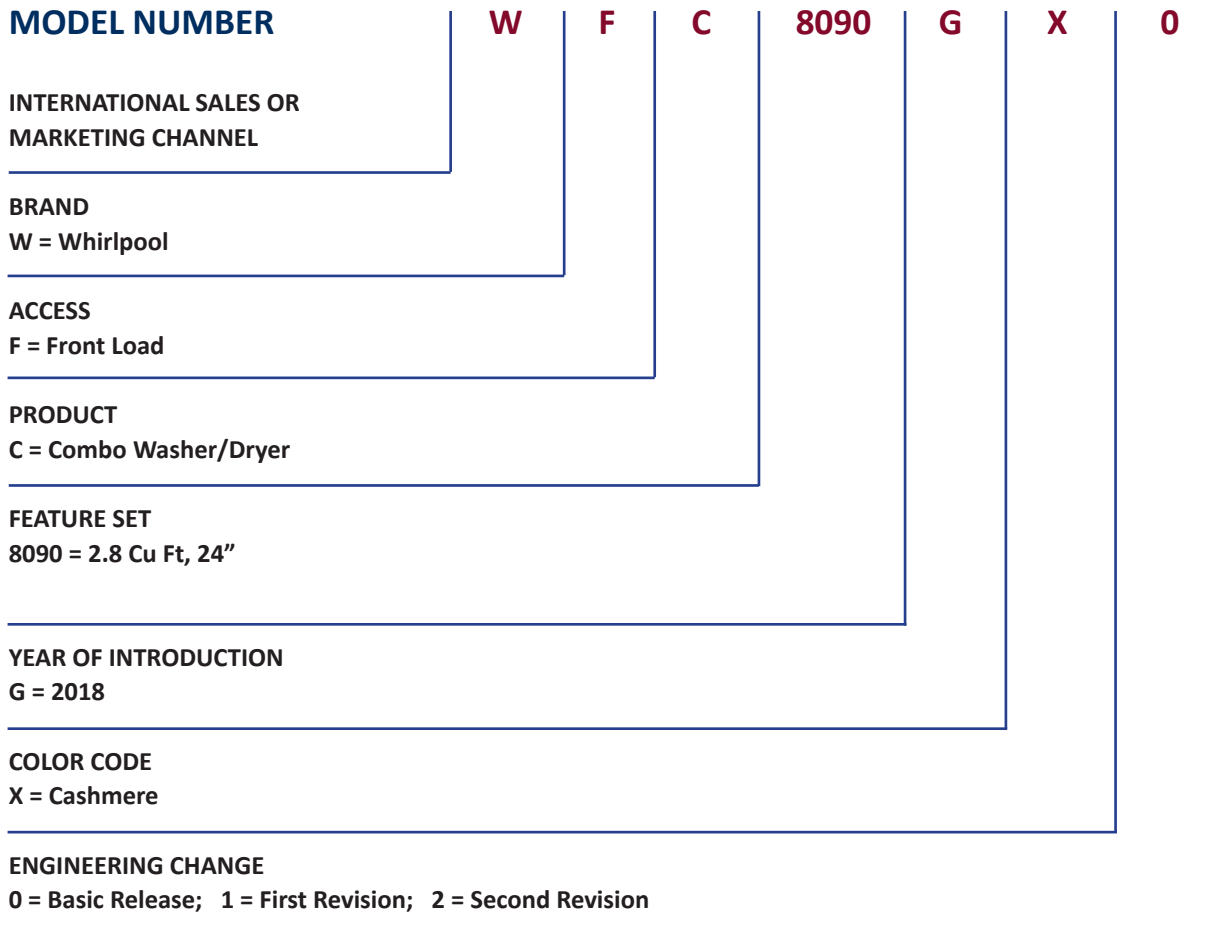

All-In-One Washer/Dryer Maintenance

Washer/Dryer Care

Recommendations to Help Keep Your Washer/Dryer Clean and Performing at Its Best

1. Always use High Efficiency (HE) detergents and follow the HE detergent manufacturer's instructions regarding the amount of HE detergent to use. Never use more than the recommended amount because that may increase the rate at which detergent and soil residue accumulate inside your washer, which in turn may result in undesirable odor.
2. Use warm or hot water washes sometimes (not exclusively cold water washes), because they do a better job of controlling the rate at which soils and detergent accumulate.
3. Always leave the washer door slightly ajar between uses to help dry out the washer and avoid the buildup of odor-causing residue.
4. Periodically clean residue from all interior surfaces of the glass window. For better care, wipe the entire inside of the glass door with a damp cloth.

Cleaning Your Front-Loading Washer

Read these instructions completely before beginning the routine cleaning processes recommended below. This Washer Maintenance Procedure should be performed, at a minimum, once per month or every 30 wash cycles, whichever occurs sooner, to control the rate at which soils and detergent may otherwise accumulate in your washer.

Cleaning the Door Seal

1. Open the washer door and remove any clothing or items from the washer.
2. Inspect the seal between the door opening and the drum for stained areas or soil buildup. Pull back the seal to inspect all areas under the seal and to check for foreign objects.
3. If stained areas or soil buildup are found, wipe down these areas of the seal using the following procedure:
When the cycle is complete, gently pull back the rubber door seal and clean the entire surface with the textured side of an affresh® Machine Cleaning Wipe.

Cleaning the Inside of the Washer

This washer has a special cycle that uses higher water volumes in combination with affresh® Washer Cleaner to thoroughly clean the inside of the washer.

NOTE: Read these instructions completely before beginning the cleaning process.

Begin procedure

Clean Washer with affresh® Cycle Procedure (Recommended for Best Performance):

- a. Open the washer door and remove any clothing or items.
- b. Use an affresh® Machine Cleaning Wipe or a soft, damp cloth or sponge to clean the inside door glass.
- c. Add an affresh® Washer Cleaner tablet to the washer drum.
- d. Do not add the affresh® Washer Cleaner tablet to the bulk dispenser.
- e. Do not add any detergent or other chemical to the washer when following this procedure.
- f. Close the washer door.
- g. Select the Clean Washer with affresh® cycle.
- h. Select the TumbleFresh™ option to help dry the washer interior after the cycle is complete.
NOTE: The washer remembers your last option selection and will use it for future wash cycles until you deselect that option.
- i. Touch the START/PAUSE button to begin the cycle. The Clean Washer with affresh® cycle operation is described below.

Description of Clean Washer with affresh® Cycle Operation:

1. Do not run this cycle with a load. Doing so could damage the items.
2. After the cycle is complete, leave the door open slightly to allow for better ventilation and drying of the washer interior.

Cleaning the Load & Go™ Bulk Dispenser

After a period of using your washer/dryer, you may find some residue buildup in the Load & Go™ bulk dispenser. To remove residue from the dispensers, lift the handle on the dispenser housing to remove it from the washer/dryer cabinet, then rinse the two dispensers thoroughly with running water. Wipe the outside dispenser surfaces with an affresh® Machine Cleaning Wipe or a damp cloth and towel dry. Use an all-purpose surface cleaner, if needed. Replace the dispenser in the washer/dryer cabinet and make sure that it is seated.

IMPORTANT: Load & Go™ bulk dispenser is not dishwasher safe.

Cleaning the Outside of the Washer/Dryer

Use an affresh® Machine Cleaning Wipe or a soft, damp cloth or sponge to wipe up any spills. Occasionally wipe the outside of your washer/dryer to help keep it looking new. Use an affresh® Machine Cleaning Wipe or mild soap and water. **IMPORTANT:** To avoid damaging the washer/dryer finish, do not use abrasive products.

All-In-One Washer/Dryer Maintenance (continued)

Clean Washer Cycle Reminder

The Clean Washer with affresh® message will flash at the end of a wash cycle when the washer has run 30 wash cycles. This is a reminder to run the Clean Washer with affresh® cycle.

If the Clean Washer with affresh® cycle is not run, the message will stop flashing at the end of a wash cycle after running three more regular wash cycles. After 30 more wash cycles are completed, the Clean Washer with affresh® message will again flash at the end of a wash cycle as a reminder.

Removing the Load & Go Bulk Dispenser

To remove:

1. Lift the bulk dispenser lid on the top of the washer/dryer.
2. Lift up on the bulk dispenser handle and pull straight up and out of the washer/dryer.



To replace:

1. Place the bulk dispenser back into the bulk dispenser cavity on the top of the washer/dryer and make sure that it is seated.
2. Close the bulk dispenser lid.

Water Inlet Hose

Replace inlet hose after 5 years of use to reduce the risk of hose failure. Periodically inspect and replace inlet hose if bulges, kinks, cuts, wear, or leaks are found.

When replacing your inlet hose:

- Mark the date of replacement on the label with a permanent marker.
- Check that the old washer is not stuck on the washer inlet valve.
- Use a new washer in the new inlet hose to ensure a proper seal.

Non-Use and Vacation Care

If moving, or not using your washer/dryer for a period of time, follow these steps:

1. Unplug or disconnect power to washer/dryer.
2. Turn off water supply to washer/dryer to avoid flooding due to water pressure surges.

HELPFUL TIP: Attach a reminder note to the washer/dryer to turn the water back on before washer's next use.

3. Clean the bulk dispenser. See "Cleaning the Bulk Dispenser."

Winter Storage Care

IMPORTANT: To avoid damage, install and store washer/dryer where it will not freeze. Because some water may stay in hoses, freezing can damage washer/dryer. If storing or moving during freezing weather, winterize your washer/dryer.

To winterize washer/dryer:

1. Shut off water faucet, disconnect and drain water inlet hose.

HELPFUL TIP: Attach a reminder note to the washer dryer to turn the water back on before washer's next use.
2. Remove drain pump filter.
3. Put 1 qt. (1 L) of R.V.-type antifreeze in drum and run washer on Normal cycle for about 2 minutes to mix antifreeze and remaining water.
4. Unplug washer/dryer or disconnect power.

Cleaning the Drain Pump Filter/Draining Residual Water

Cleaning the Drain Pump Filter/ Draining Residual Water

⚠ WARNING

Electrical Shock Hazard
Disconnect power before cleaning.
Replace all parts and panels before operating.
Failure to do so can result in death or electrical shock.

NOTE: Perform the following procedure every 6 months.

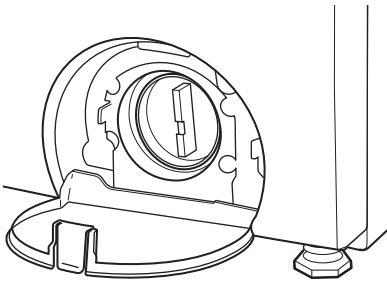
1. Open the drain pump filter access door at the bottom right corner at the front of the washer/dryer.

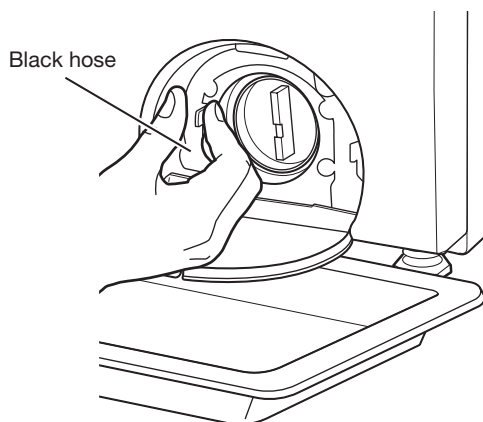

2. Place a broad, flat container beneath the drain pump filter to collect the drain water. Pull out the black hose, remove the plug, and drain the hose into the container. Empty the container. Repeat this procedure if necessary until all the water has drained. Make sure that the black hose is completely dry.



3. Lay a cotton cloth beneath the drain pump filter to absorb any water still in it. Then remove the drain pump filter by turning it counterclockwise.



4. Remove large clumps of lint by hand from the filter and place lint in a suitable waste container. Remove remaining residue from the filter by rinsing with water.

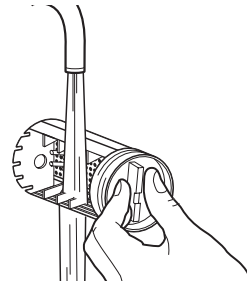

5. Reinsert the drain pump filter by turning it clockwise. Make sure to turn it in as far as it will go, with the filter handle left in a vertical position.

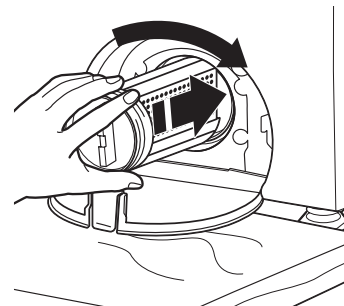

How to Manually Open a Locked Door

How to Manually Open the Door

1. Open the drain pump filter access door at the bottom right corner at the front of the washer/dryer. With a Phillips head screwdriver, loosen and remove the Phillips head screw at the upper right portion of the access door compartment. (See Figure 1.)
3. Secure the plastic strap by replacing and tightening the Phillips head screw removed in Step 1 through the hole in the strap. (See Figure 3.)

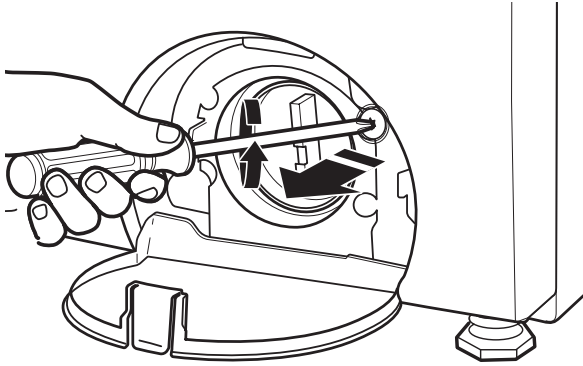

Figure 1

2. Pull down on the plastic strap located beneath the removed screw. The door can now be opened. (See Figure 2.)

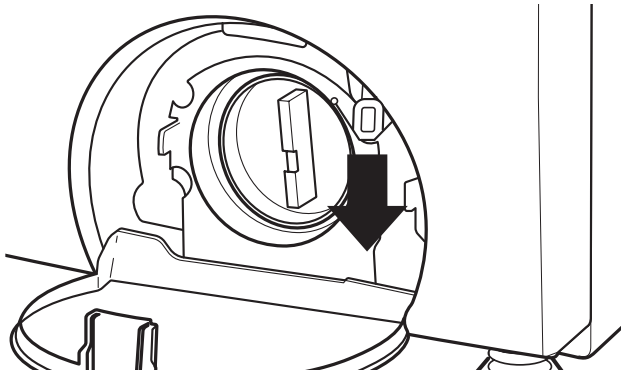

Figure 2

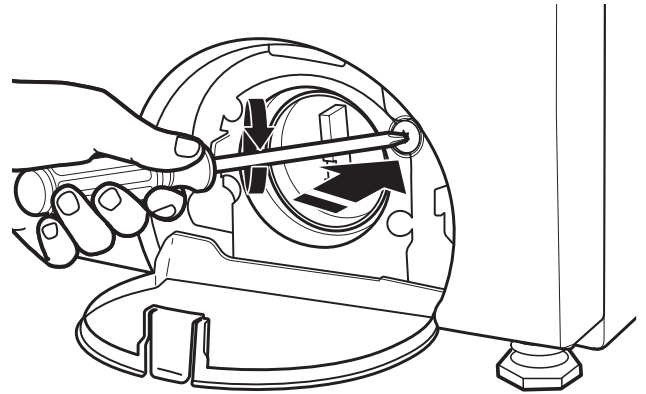

Figure 3

Notes

Section 2: Diagnostics & Troubleshooting

This section provides diagnostic, fault codes, and troubleshooting information for the “Whirlpool Smart All-In-One Washer & Dryer.”

- Control Panel
- Abbreviations
- Diagnostic Guide
- Service Diagnostic Mode
- Activating Service Diagnostic Mode
- Service Diagnostic Mode Test
- Fault/Error Codes
- Troubleshooting Guide

For Service Technician Use Only

CONTROL PANEL (buttons to use when entering Service Diagnostic Mode and Tests

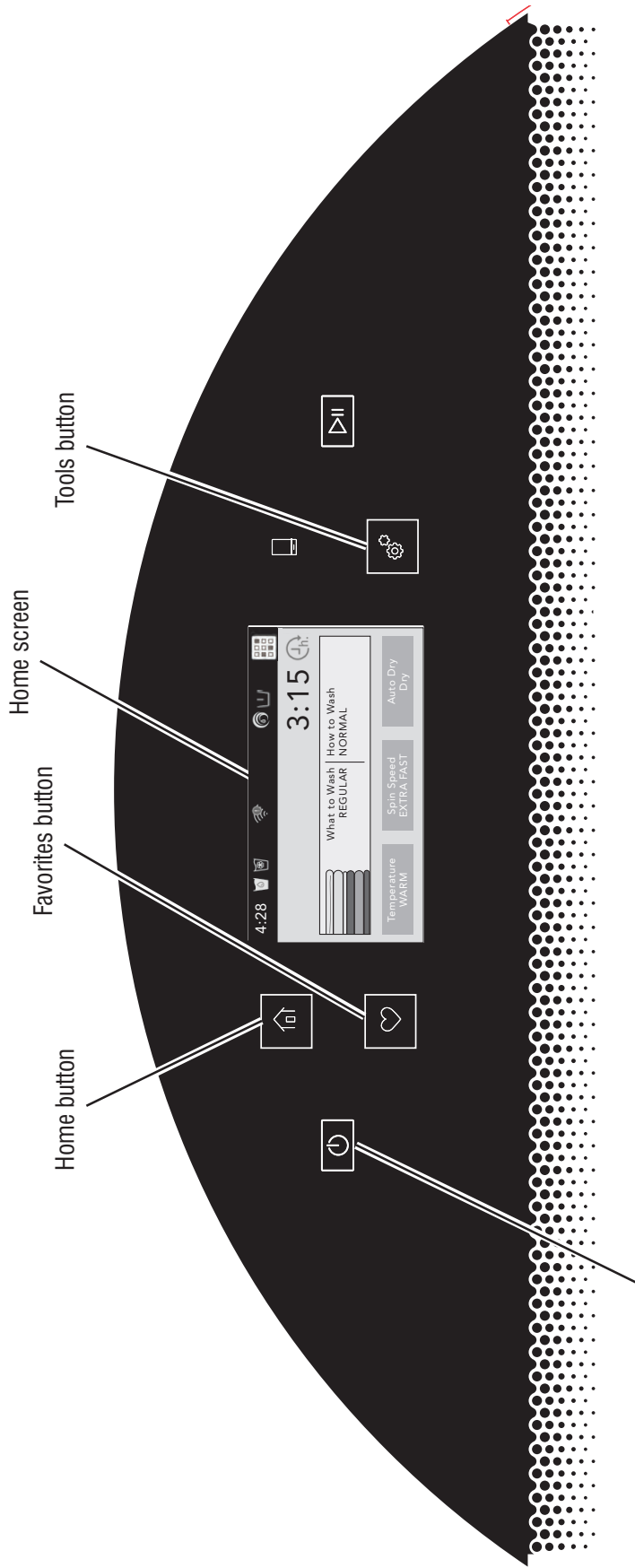

1. Press and hold the POWER button until the display turns on. After approximately 1 minute, the display will show the Home screen, as indicated above.
2. Press the HOME button, the FAVORITES button, and the TOOLS button three times within 8 seconds (↑ / ♥ / ⚙️ / ↑ / ♥ / ⚙️ / ↑ / ♥ / ⚙️). Make sure a tone sounds for each button press. The WARNING DIAGNOSTIC MODE screen will display. Touch ENTER to enter diagnostic mode.

Figure 1 - Human Machine Interface (HMI)

For Service Technician Use Only

ABBREVIATIONS

ACU: Appliance Control Unit

HMI: Human-Machine Interface

DIAGNOSTIC GUIDE

Before servicing, check the following:



- Make sure there is power at the wall outlet.
- Has a household fuse blown, or circuit breaker or GFCI tripped? Was a regular fuse used? Inform customer that a time-delay fuse is required.
- Is cold water faucet open and water supply hose unobstructed?
- Make sure drain hose is not sealed into drain pipe, and that there is an air gap for ventilation.
- All tests/checks should be made with a VOM (volt-ohm-milliammeter) or DVM (digital-voltmeter) having a sensitivity of 20,000 Ω per volt DC or greater.
- Resistance checks must be made with washer/dryer unplugged or power disconnected.
- **IMPORTANT:** Avoid using large diameter probes when checking harness connectors as the probes may damage the connectors upon insertion.
- Check all harnesses and connections before replacing components. Look for connectors not fully seated, broken or loose wires and terminals, pin insertion, or wires not pressed into connectors far enough to engage metal barbs.
- A potential cause of a control not functioning is corrosion or contamination on connections. Use an ohmmeter to check for continuity across suspected connections.
- **IMPORTANT:** Voltage checks must be made with all connectors attached to the boards.

SERVICE DIAGNOSTIC MODE

Allows service personnel to run the Service Test Cycle to verify inputs to the washer/dryer and functionality of the washer/dryer control. You may want to do a quick and overall checkup of the washer/dryer with this test before going to specific troubleshooting tests.

ACTIVATING SERVICE DIAGNOSTIC MODE - (2 METHODS)

IMPORTANT: Use Service Diagnostic Mode without laundry in the washer/dryer.

1. Be sure the washer/dryer is in standby mode (plugged in with all indicators off).
2. Open and close the washer/dryer door.
3. Press and hold POWER until the washer/dryer display turns on. After approximately 1 minute, the home screen will display.
4. **METHOD 1: (See Figure 1, page 2-2.)**
 Within 8 seconds,
 - Press and release the HOME button ()
 - Press and release the FAVORITES button ()
 - Press and release the TOOLS button ()
 - Repeat this 3 button sequence 2 more times

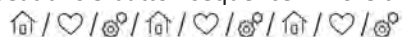

The WARNING DIAGNOSTIC MODE screen will display. Touch ENTER to enter diagnostic mode. The DIAGNOSTIC HOME screen will be displayed. To continue with the tests in Service Diagnostic Mode, see below.

METHOD 2:

- a. Press the TOOLS button - 
- b. From the TOOLS menu, scroll down to "INFO."
- c. From the INFO menu, select "SERVICE & SUPPORT."
- d. From the SERVICE INFO screen, Press and hold the DIAGNOSTICS button until the "ENTER PASSWORD" screen is displayed.
- e. From the ENTER PASSWORD screen, input "123, 123, 123," and press "ENTER."
- f. The WARNING DIAGNOSTIC MODE screen will display. Touch ENTER to enter diagnostic mode. The DIAGNOSTIC HOME screen will be displayed. To continue with the tests in Service Diagnostic Mode, see below.

Activation with Saved Fault Codes

If there is a saved fault code, the F number will be shown in the display. Review the Fault/Error Codes beginning on page 2-6 for the recommended procedure and how to display saved error codes.

To exit Service Diagnostic Mode, scroll to the top of the DIAGNOSTICS HOME screen, press the < button in the top left corner of the screen twice, and then press the HOME button.

NOTE: Service Diagnostic Mode times out after 5 minutes of user inactivity.

Unsuccessful Activation

If entry into Service Diagnostic Mode is unsuccessful, refer to the following indications and actions:

Indication 1: The display does not turn on.

Action: Make sure AC power is available to the washer/dryer. Check user interface operation (see Test #2, page 3-6).

Indication 2: Display is on, but unable to enter Service Diagnostic Mode.

Action: Press and hold POWER to turn off the washer/dryer display. Wait 10 seconds. Press and hold POWER again to turn on the washer/dryer display. Follow the Activating Service Diagnostic Mode instructions on this page.

SERVICE DIAGNOSTIC MODE TESTS

NOTE: The Service Diagnostic Mode must be activated before performing the tests; see procedure on this page.

Active Fault Code Display in Service Test Cycle

All indicators turn on and the display shows active fault code "F#E#."

Exit Procedure

To exit the Service Test Cycle, scroll to the top of the DIAGNOSTICS HOME screen, press the < button in the top left corner of the screen twice, and then press the HOME button.

For Service Technician Use Only

⚠ DANGER

<p style="text-align: center;">Electrical Shock Hazard</p> <p>Only authorized technicians should perform diagnostic voltage measurements.</p> <p>After performing voltage measurements, disconnect power before servicing.</p> <p>Failure to follow these instructions can result in death or electrical shock.</p>

⚠ WARNING

<p style="text-align: center;">Electrical Shock Hazard</p> <p>Disconnect power before servicing.</p> <p>Replace all parts and panels before operating.</p> <p>Failure to do so can result in death or electrical shock.</p>

<h3>Voltage Measurement Safety Information</h3> <p>When performing live voltage measurements, you must do the following:</p> <ul style="list-style-type: none">■ Verify the controls are in the off position so that the appliance does not start when energized.■ Allow enough space to perform the voltage measurements without obstructions.■ Keep other people a safe distance away from the appliance to prevent potential injury.■ Always use the proper testing equipment.■ After voltage measurements, always disconnect power before servicing.

SERVICE DIAGNOSTIC MODE TESTS

NOTE: The Service Diagnostic Mode must be activated before performing the tests; see procedure on page 2-3.

IMPORTANT: Turn off power or disconnect washer/dryer before attaching test leads. Be sure test leads are attached prior to component activation.

To check voltage measurements, the following steps must be followed:

1. Unplug washer/dryer or disconnect power.
2. Connect voltage measurement equipment to appropriate connectors.
3. Plug in washer/dryer or reconnect power and confirm voltage reading.
4. After performing voltage measurements, unplug washer/dryer or disconnect power

From the DIAGNOSTICS HOME screen:

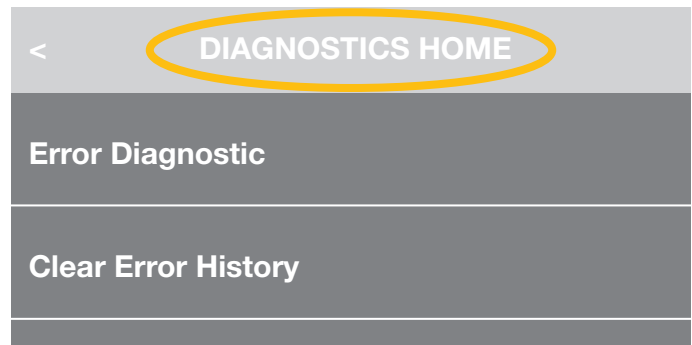

Figure 1

Scroll down and select "Component Activation"

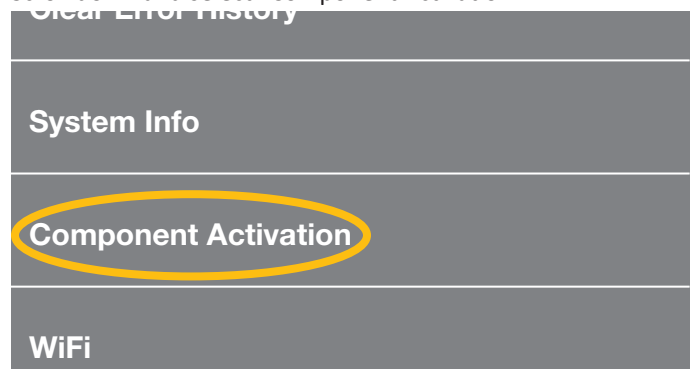

Figure 2

For Service Technician Use Only

SERVICE DIAGNOSTIC MODE TESTS (Continued)

Scroll down and select “Door Unlock” and verify the door is “Locked” (see NOTE below).

NOTE:

The “state” of the door lock reverses when you select “On” and “Off”.

For example:

- if the door is unlocked, selecting “Door Unlock” will lock the door
- if the door is locked, selecting “Door Unlock” will unlock the door

- Turn “Wash Heater” On – confirm voltage measurement. **IMPORTANT:** Turn “Wash Heater” On *only* long enough to test voltage, otherwise damage to component may result.
- Turn “Wash Heater” Off
- Turn “Dry Heater” On – confirm voltage measurement. **IMPORTANT:** Turn “Dry Heater” On *only* long enough to test voltage, otherwise damage to TCO’s may result.
- Turn “Dry Heater” Off
- Skip “Door Unlock”

Wash Heater	Off
Dry Heater	Off
Door Unlock	Off

Figure 3

Wash Heater	Off
Dry Heater	Off
Door Unlock	“Skip”

Figure 5

Scroll back up and turn on loads as follows:

- Turn “Motor Turn Left/CCW” On – confirm CCW drum rotation
- Turn “Motor Turn Left/CCW” Off
- Turn “Motor Turn Left and Right” On – confirm left and right drum rotation
- Turn “Motor Turn Left and Right” Off

- Turn “Drain Pump” On – confirm voltage measurement
- Turn “Drain Pump” Off
- Turn “Recirculation Pump” On – confirm voltage measurement
- Turn “Recirculation Pump” Off
- Turn “Dry Fan” On – confirm voltage measurement
- Turn “Dry Fan” Off

Component Activation	
Motor Turn Left /CCW	Off
Motor Turn Left and Right	Off

Figure 4

Drain Pump	Off
Recirculation Pump	Off
Dry Fan	Off

Figure 6

For Service Technician Use Only

SERVICE DIAGNOSTIC MODE TESTS (Continued)

- Turn “Cold Water Valve” On – confirm voltage measurement
- Turn “Cold Water Valve” Off
- Turn “Condensation Valve” On – confirm voltage measurement
- Turn “Condensation Valve” Off
- Turn “Detergent Pump” On – confirm voltage measurement
- Turn “Detergent Pump” Off

Cold Water Valve	Off
Condensation Valve	Off
Detergent Pump	Off

Figure 7

- Turn “Softener Pump” On – confirm voltage measurement
- Turn “Softener Pump” Off
- Skip “Spray Valve” (not available on this model)
- Skip “Strong Off” On (not available on this model)

Softener Pump	“Skip”	Off
Spray Valve	“Skip”	Off
Strong Off		Off

Figure 8

- Skip “Unbalance Detection” (not available on this model)

Spray Valve	“Skip”	Off
Strong Off	“Skip”	Off
Unbalance Detection	“Skip”	Off

Figure 9

Exit Service Diagnostic Mode by scrolling to the top and pressing the < button in the top left corner of the screen twice, and then pressing the HOME button.

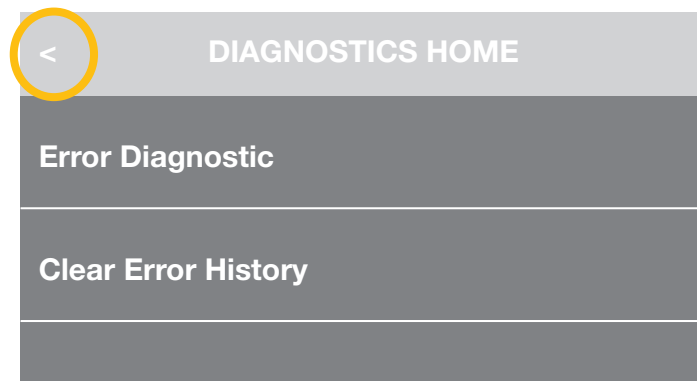



Figure 10

For Service Technician Use Only

⚠ WARNING



Electrical Shock Hazard

Disconnect power before servicing.

Replace all parts and panels before operating.

Failure to do so can result in death or electrical shock.

FAULT/ERROR CODES

Fault/Error Code Display Method

Fault codes are displayed by showing F#E#. The F# indicates the suspect System/Category. The E# indicates the suspect Component system.

The fault codes below may be indicated under various conditions and can be accessed through Service Diagnostics.

Fault Error Code	Description	
FOE1	Load in drum during Clean Washer cycle	Remove load and re-start Clean Washer cycle.
FOE2	Oversuds	Excessive suds in washer. Washer is running a suds reduction routine. If the washer is unable to correct the problem, this may indicate: <ul style="list-style-type: none"> • Not using HE detergent. • Excessive detergent usage. • Check pressure hose connection from tub to main control. Is hose pinched, kinked, plugged, or leaking air.
FOE3	High temp error, dry cycle, no air flow	Detected dryer fan not functioning properly. Try recycling power to washer/dryer. <ul style="list-style-type: none"> • Check thermal cut-off. See TEST #12a: Dry Heating Element, pg. 3-19. • Check dry NTC. See TEST #12b: Dry Temperature Sensor (NTC), pg. 3-20. • Check dry fan motor. See TEST #13: Dry Fan Motor, pg. 3-21.
FOE4	High temp error, wash cycle	Washer water too hot. May have water inlet hose connected to hot water faucet. <ul style="list-style-type: none"> • Make sure inlet hose is connected to a cold water faucet. • Check wash heat element. See TEST #8: Wash Heating Element, pg. 3-12. • Check wash temperature sensor. See TEST #9: Wash Temperature Sensor, pg. 3-13.
FOE5	Off Balance Load	Load could be unbalanced or too large. Avoid tightly packing the load. Avoid washing single items.
F1E2	MCU over- or under-voltage error	MCU malfunction, voltage out of range. <ul style="list-style-type: none"> • See TEST #3: Motor Circuit, page 3-7.
F1E4	Main relay open or shorted	Main relay issue. Try recycling power to washer/dryer. <ul style="list-style-type: none"> • See TEST #1: ACU Power Check, pg. 3-4.
F3E1	Pressure switch signal missing or out of range	See TEST #6: Pressure Switch, pg. -10.
F3E2	Wash NTC open or shorted	See TEST #9: Wash Temperature Sensor, pg. 3-13. See TEST #12b: Dry Thermistor Sensor, pg. 3-20.

Continued on following page . . .

For Service Technician Use Only

FAULT/ERROR CODES (continued)

Fault Error Code	Description	
F3E3	Dry thermistor NTC open or shorted	See TEST #12b: Dry Thermistor Sensor, pg. 3-20.
F4E1	Wash heater relay error	See TEST #8: Wash Heating Element, pg. 3-12.
F4E2	Dry heater relay error	See TEST #12a: Dry Heating Element, pg. 3-19.
F4E3	Dry fan motor error	See TEST #13: Dry Fan Motor, pg. 3-21.
F5E1	Door switch error	See TEST #4: Door Lock System, pg. 3-8.
F5E2	Lock failure	See TEST #4: Door Lock System, pg. 3-8.
F5E3	Unlock failure	See TEST #4: Door Lock System, pg. 3-8.
F5E4	Door not open error	Make sure to open and close the washer/dryer door between cycles.
F6E1	Communication between the Appliance Control Unit (ACU) and Motor Control Unit (MCU) has not been detected.	Try recycling power to washer/dryer. <ul style="list-style-type: none"> • Verify continuity in cable between ACU (J17) and MCU (J3). See wiring diagram on page 3-3. • Check AC and DC supplies. See TEST #1 (ACU Power Check) on page 3-4. • See TEST #2 Human Machine Interface on page 3-6.
F6E2	Communication between the Appliance Control Unit (ACU) and Human Machine Interface (HMI) has not been detected.	Try recycling power to washer/dryer. <ul style="list-style-type: none"> • Verify continuity in cable between ACU (J16) and HMI (CN1). See wiring diagram on page 3-3. • Check AC and DC supplies. See TEST #1 (ACU Power Check) on page 3-4. • See TEST #2 Human Machine Interface on page 3-6.
F6E3	Unknown cycle ID error	See TEST #1: ACU Power Check, pg. 3-4.
F7E2	MCU over temp error	<ul style="list-style-type: none"> • Check for obstruction between spin basket and outer tub. • Check harness continuity and connections between ACU and motor. See TEST #3: Motor Circuit, pg. 3-7.
F7E3	MCU over current error/internal failure.	See TEST #3: Motor Circuit, pg. 3-7.
F7E4	Motor disconnected error	Check harness continuity and connections between ACU and motor. See TEST #3: Motor Circuit, pg. 3-7.
F7E8	Motor over temp error	<ul style="list-style-type: none"> • Check for obstruction between spin basket and outer tub. • Check harness continuity and connections between ACU and motor. See TEST #3: Motor Circuit, pg. 3-7.
F7E9	Locked rotor	See TEST #3: Motor Circuit, pg. 3-7.
F8E1	Inlet valve error/fill timeout	See TEST #5: Inlet Valve, pg. 3-9.
F8E3	Overflow	Make sure drain hose and drain pump filter are not plugged. Verify functionality of water inlet valve, water level sensor, and drain/recirculation pump. <ul style="list-style-type: none"> • See TEST #5: Inlet Valve, pg. 3-9. • See TEST #6: Pressure Switch, pg. 3-10. • See TEST #7: Drain/Recirculation Pump, pg. 3-11.
F9E1	Long drain/drain timeout	Check drain hose installation for proper height, check drain hose and filter for obstructions, and make sure drain hose is not sealed into drain pipe. Check functionality of drain/recirculation pump. <ul style="list-style-type: none"> • See TEST #7: Drain/Recirculation Pump, pg. 3-11.

For Service Technician Use Only

TROUBLESHOOTING GUIDE

NOTE: Always check for error/fault codes first (page 2-6)

Some tests will require accessing components. See Section 4, "Component Access" for component locations. For detailed testing procedures, refer to Section 3, "Component Testing."

Problem	Possible Cause	Checks & Tests
Won't Power Up <ul style="list-style-type: none"> No operation No keypad response No display 	No power to washer/dryer	Check power at outlet, check circuit breakers, fuses, or junction box connections.
	Connection problem between AC plug and ACU.	Check connections between the AC power cord and ACU for continuity.
	Connections between ACU and UI.	Check connections and harness continuity between the ACU and HMI.
	ACU problem.	See TEST #1: ACU Power Check, page 3-4.
	HMI problem.	See TEST #2: Human-Machine Interface (HMI), page 3-6.
Won't Start Cycle No response when START is pressed	Control lock is activated.	Check if the control lock icon above the Start button is on. If so, press and hold to deactivate it.
	Door lock mechanism not functioning.	1. Door not closed due to interference. 2. Lock not closed due to interference. 3. See TEST #4: Door Lock System, page 3-8.
	Connections between ACU and HMI.	Check connections and harness continuity between ACU and HMI.
	HMI problem.	See TEST #2: Human-Machine Interface (HMI), page 3-6.
	ACU problem.	See TEST #1: ACU Power Check, page 3-4.
HMI Won't Accept Selections	Control lock is activated.	Deactivate the control lock.
	Connections between ACU and HMI.	Check connections and harness continuity between ACU and HMI.
	HMI problem.	See TEST #2: Human-Machine Interface (HMI), page 3-6.
	ACU problem.	See TEST #1: ACU Power Check, page 3-4.
Door Won't Lock	Door not closed.	Ensure that door is completely closed.
	Door lock obstructed.	Check mechanism for obstruction.
	Door lock mechanism not functioning.	See TEST #4: Door Lock System, page 3-8.
Door Won't Unlock (See page 2-2 for manually unlocking the door lock system.)	Reset washer/dryer.	Unplug the washer/dryer, wait 30 seconds, and reconnect the power cord. Wait 2 minutes to see if the washer/dryer door unlocks.
	Misaligned, broken, or over-tightened door latch.	Check door lock mechanism and repair as necessary.
	Door lock mechanism not functioning.	See TEST #4: Door Lock System, page 3-8.
Won't Dispense	No water supplied to washer.	1. Check water connections to washer. 2. Verify that water supply is turned on.
	Dispenser clogged with detergent.	Clean obstruction from dispenser.
	Valve problem	See TEST #5: Inlet Valve, page 3-9.
	Dispenser system problem.	See TEST #10a & 10b: Dispenser System, page 3-14 to 3-16.

Continued on following page . . .

For Service Technician Use Only

TROUBLESHOOTING GUIDE (continued)

Problem	Possible Cause	Checks & Tests
Won't Fill	No water supplied to washer or low water pressure.	1. Check water connections to washer. 2. Verify that water supply is turned on.
	Plugged filter/screen.	Check for plugged filter or screen in the inlet valve or hose.
	Drain hose installation.	Check for proper drain hose installation. Is water siphoning out of the drain hose?
	Inlet valve problem.	See TEST #5: Inlet Valve, page 3-9.
	Pressure switch problem.	See TEST #6: Pressure Switch, page 3-10.
Overfills	Drain hose/filter or air trap is plugged.	Check for hose, drain filter, and air trap obstructions.
	Inlet valve not shutting off.	See TEST #5: Inlet Valve, page 3-9.
	Pressure switch problem.	See TEST #6: Pressure Switch, page 3-10.
	Drain pump problem.	See TEST #7: Drain/Recirculation Pump, page 3-11.
Drum Won't Rotate	Door is not locked. Is door locking after starting a cycle?	Verify harness connections and see TEST #4: Door Lock System, page 3-8.
	Garment or mechanical obstruction between drum and tub.	Try to move the drum while the washer is unpowered to see if it can move freely. If not, check for a garment or other object obstructing movement.
	Harness connections.	Check harness continuity and connections between ACU and motor.
	Motor problem.	See TEST #3: Motor Circuit, page 3-7.
Motor Overheats	Mechanical friction.	Check for obstruction between spin basket and outer tub.
	Harness connections.	Check harness continuity and connections between ACU and motor.
	Motor problem.	See TEST #3: Motor Circuit, page 3-7.
Won't Drain	Drain hose installation.	Reduce drain height if it is >49". Make sure drain hose is not inserted more than 4.5" (114 mm). Make sure drain hose is not sealed into drain pipe, and that there is an air gap for ventilation.
	Plugged drain hose or air trap.	Check drain hose and air trap for obstructions.
	Obstructions to drain pump.	Check and clean drain filter of obstructions.
	Harness connections.	Check harness continuity and connections between ACU and drain pump.
	Drain pump problem.	See TEST #7: Drain/Recirculation Pump, page 3-11.
Incorrect Water Temperature	Heating element problem.	See TEST #8: Wash Heating Element, page 3-12.
	Temperature sensor problem.	See TEST #9: Wash Temperature Sensor, page 3-13.
Leaking	Supply hose connection.	Check hose connection and for damage to rubber gasket due to over-tightening.
	Drain hose installation.	Check for proper drain hose installation.
	Plugged drain hose or house drain pipe.	Check drain hose for obstructions and make sure house drain pipe is not blocked.
	Overloading the washer/dryer	Overloading can partially push the door open.
	Internal hose connections.	Check internal hose connections for leakage.
	Check bellow.	Check for holes in the bellow. If there are none, remove, reposition, and reinstall the bellow. Make sure the bellow is not wrinkled.

Continued on following page . . .

For Service Technician Use Only

TRUBLESHOOTING GUIDE (continued)

Problem	Possible Cause	Checks & Tests
Leaking (continued)	Dispensers leaking.	Check the dispensers for leakage from the front and from the plastic box itself.
	Ventilation tube leaking.	Make sure that the ventilation tube is installed properly.
	Heater leaking.	Make sure heater is seated and torqued down properly.
Vibration or Noise	Heater is loose.	Make sure heater is torqued down properly.
	Shipping kit not removed.	Verify that shipping bolts and spacers are removed.
	Washer not level.	Level washer/dryer per installation instructions.
	Floor stability.	Weak floors can cause vibration and walking of the washer/dryer.
	Leveling lock nuts not tightened.	Tighten leveling lock nuts.
	Clogged inlet screen making high-pitched noise.	Disconnect hose and clean screen.
	Spring/damper installation.	Check for proper spring and damper placement and installation.
	Washer/dryer panel noise.	Inspect washer/dryer panels for bending, warpage, or damage. Check for loose fasteners.
	Ventilation hose becoming disconnected.	Verify connection of ventilation hose.
	Pressure switch hose slapping on the tub.	Make sure the hose is fastened properly.
Poor Wash Performance Please reference Use & Care Guide	Oversuds.	1. Verify use of HE detergent. 2. Excessive detergent usage. 3. Check drain hose and filter for obstructions.
	Incorrect water level.	See "WON'T FILL", page 2-10.
	Clothes wet after cycle is complete.	1. Single or tangled items in the washer/dryer. 2. Oversuds (see above). 3. See "WON'T DRAIN", page 2-10.
	Load not rinsed.	1. Check proper water supply. 2. Not using HE detergent. 3. Verify that load is not bunched or bundled when placed in washer/dryer. 4. See TEST #5: Inlet Valve, page 3-9.
	Not cleaning clothes.	1. Verify that load is not bunched or bundled when placed in washer/dryer. 2. Not using HE detergent. 3. Not using correct cycle. 4. Not using dispensers.
	Fabric damage.	1. Washer/dryer overloaded. 2. Sharp items in tub.
	Wrong option or cycle selection.	Refer customer to "Use & Care Guide/Installation Instructions".
Dry Cycle Will Not Shut Off When Expected	Poor airflow.	Check drain pump filter. Clean if necessary.
	Thermistor problem.	See TEST #12b: Dry Temperature Sensor, pg. 3-20.
	Connections between ACU and HMI.	Check connections and harness continuity between ACU and HMI.
	ACU problem.	See TEST #1: ACU Power Check, pg. 3-4.

Continued on following page . . .

For Service Technician Use Only**TROUBLESHOOTING GUIDE (continued)**

Problem	Possible Cause	Checks & Tests
Dryer Cycle Will Not Heat	Check installation.	Verify proper washer/dryer installation.
	Check for L1 and L2.	See TEST #11: Supply Connections, pg. 3-17.
	Heater system malfunction.	See TEST #12a: Dry Heating Element, pg. 3-19.
	Thermistor problem.	See TEST #12b: Dry Temperature Sensor, pg. 3-20.
	ACU problem.	See TEST #1: ACU Power Check, pg. 3-4.
	TCO problem.	See TEST #12a: Dry Heating Element, pg. 3-19.
Shuts Off Before Clothes Are Dry in Auto Dry Setting	Drain pump filter is clogged.	Clean filter if necessary. Refer customer to Use and Care Guide/ Installation Instructions.
	Dryness setting for auto dry cycles.	Increase dryness level setting.
	Thermistor problem.	See TEST #12b: Dry Temperature Sensor, pg. 3-20.

Notes

Section 3:

Component Testing

This section provides a wiring diagram, control board specifications, testing procedures and strip circuits for the “Whirlpool Smart All-In-One Washer & Dryer.”

- Testing: Safety Information
- Wiring Diagram
- Component Testing
- TEST #1: ACU Power Check
- TEST #2: Human-Machine Interface (HMI)
- TEST #3: Motor Circuit
- TEST #4: Door Lock System
- TEST #5: Inlet Valve
- TEST #6: Pressure Switch
- TEST #7: Drain/Recirculation Pump
- TEST #8: Wash Heating Element
- TEST #9: Wash Temperature Sensor
- TEST #10a: Dispenser Sensing
- TEST #10b: Dispenser Metering Pumps
- TEST #11: Supply Connections—U.S. & Canada
- TEST #12a: Dry Heating Element
- TEST #12b: Dry Temperature Sensor
- TEST #13: Dry Fan Motor

For Service Technician Use Only

⚠ DANGER

Electrical Shock Hazard
<p>Only authorized technicians should perform diagnostic voltage measurements.</p> <p>After performing voltage measurements, disconnect power before servicing.</p> <p>Failure to follow these instructions can result in death or electrical shock.</p>

⚠ WARNING

Electrical Shock Hazard
<p>Disconnect power before servicing.</p> <p>Replace all parts and panels before operating.</p> <p>Failure to do so can result in death or electrical shock.</p>

Voltage Measurement Safety Information

When performing live voltage measurements, you must do the following:

- Verify the controls are in the off position so that the appliance does not start when energized.
- Allow enough space to perform the voltage measurements without obstructions.
- Keep other people a safe distance away from the appliance to prevent potential injury.
- Always use the proper testing equipment.
- After voltage measurements, always disconnect power before servicing.

IMPORTANT: Electrostatic Discharge (ESD) Sensitive Electronics

ESD problems are present everywhere. Most people begin to feel an ESD discharge at approximately 3000V. It takes as little as 10V to destroy, damage, or weaken the main control assembly. The new main control assembly may appear to work well after repair is finished, but a malfunction may occur at a later date due to ESD stress.

- Use an anti-static wrist strap. Connect wrist strap to green ground connection point or unpainted metal in the appliance

-OR-

- Touch your finger repeatedly to a green ground connection point or unpainted metal in the appliance.
- Before removing the part from its package, touch the anti-static bag to a green ground connection point or unpainted metal in the appliance.
- Avoid touching electronic parts or terminal contacts; handle electronic control assembly by edges only.
- When repackaging main control assembly in anti-static bag, observe above instructions.

IMPORTANT SAFETY NOTICE — “For Technicians only”

This service data sheet is intended for use by persons having electrical, electronic, and mechanical experience and knowledge at a level generally considered acceptable in the appliance repair trade. Any attempt to repair a major appliance may result in personal injury and property damage. The manufacturer or seller cannot be responsible, nor assume any liability for injury or damage of any kind arising from the use of this data sheet.

For Service Technician Use Only

WIRING DIAGRAM

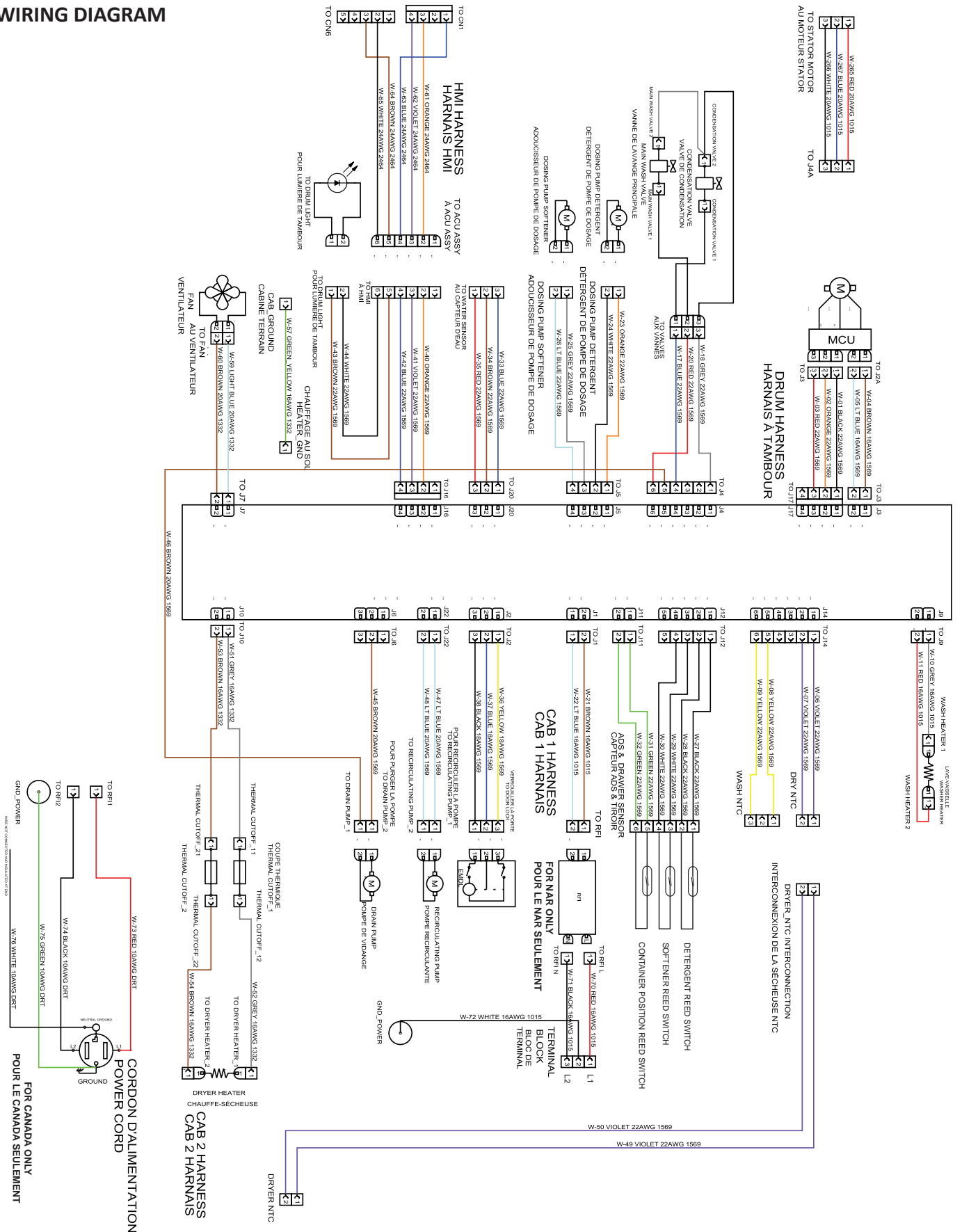

Downloaded from www.Manualslib.com manuals search engine

For Service Technician Use Only

⚠ DANGER



Electrical Shock Hazard

Only authorized technicians should perform diagnostic voltage measurements.

After performing voltage measurements, disconnect power before servicing.

Failure to follow these instructions can result in death or electrical shock.

Component Testing

TESTING WASHER COMPONENTS FROM THE CONTROL

Before testing any of the components, perform the following checks:

- The most common cause for mis-diagnosed control failure is poor connections. Therefore, disconnecting, inspecting and reconnecting wires will be necessary throughout test procedures.
- All tests/checks should be made with a VOM or DVM having a sensitivity of 20,000 ohms-per-volt DC, or greater.
- Check all connections before replacing components, looking for broken or loose wires, failed terminals, or wires not pressed into connectors far enough.
- **IMPORTANT:** Voltage checks must be made with all connectors attached to the boards.
- Resistance checks must be made with power cord unplugged or power disconnected, and with wiring harness or connectors disconnected from the control.
- **IMPORTANT:** The following procedures may require the use of needle probes to measure voltage. Failure to use needle probes will damage the connectors.

TEST #1: Appliance Control Unit (ACU) Power Check

This test checks for incoming and outgoing power to and from Appliance Control Unit (ACU). This test assumes that proper voltage is present at the outlet.

1. Unplug washer/dryer or disconnect power.
2. Visually check that all connections to the RFI filter are securely connected. See Figure 1, below.
3. Gently lay washer/dryer on its right side to access the ACU. Remove AC shield and ACU cover.
4. Visually check that all connections to the ACU are fully inserted. See Figure 2, page 3-5.
5. If both visual checks pass, go to step 6.
6. Plug in washer/dryer or reconnect power.
7. With a voltmeter set to **AC**, check for line voltage at the input of the RFI filter. See Figure 1.
 - If line voltage is present, go to step 8.
 - If line voltage is not present, verify the continuity of the power cord. If it fails the continuity check, replace the power cord.
8. With a voltmeter set to **AC**, check for line voltage at the output of the RFI filter. See Figure 1.
 - If line voltage is present, go to step 9.
 - If line voltage is not present, replace the RFI filter.
9. With a voltmeter set to **AC**, check for input line voltage to the ACU across pins 1 and 2 of connector J1. See Figure 2.
 - If line voltage is present, go to step 10.
 - If line voltage is not present, check harnesses and connections between the filter and the ACU. Visually inspect inside connector housing for bent or damaged terminals. Repair as necessary.
10. Check HMI input voltage:

With a voltmeter set to **DC**, verify that there is 12V between pin 3 and 4 at **J16**.

 - If there is 12V, go to step 11.
 - If there is not 12V, disconnect J16 and recheck for 12V between pin 3 and 4. If there is not 12V, replace the ACU. If 12V returns, check ACU to HMI harness for short. If harness is good, then replace the HMI.
11. Unplug washer/dryer or disconnect power.
12. Reassemble all parts and panels.
13. Perform the Service Diagnostic Mode Tests on page 2-3 to verify repairs.

RFI FILTER - FIGURE 1

L1 Output to ACU J1, Pin 2 (Brown Wire)

L2 Output to ACU J1, Pin 1 (Lt Blue Wire)



L1 Input to RFI Filter (Red Wire)

L2 Input to RFI Filter (Black Wire)

For Service Technician Use Only

ACU CONNECTORS - FIGURE 2

*NOTE: Do not cross-connect J16 (HMI) and J17 (MCU).

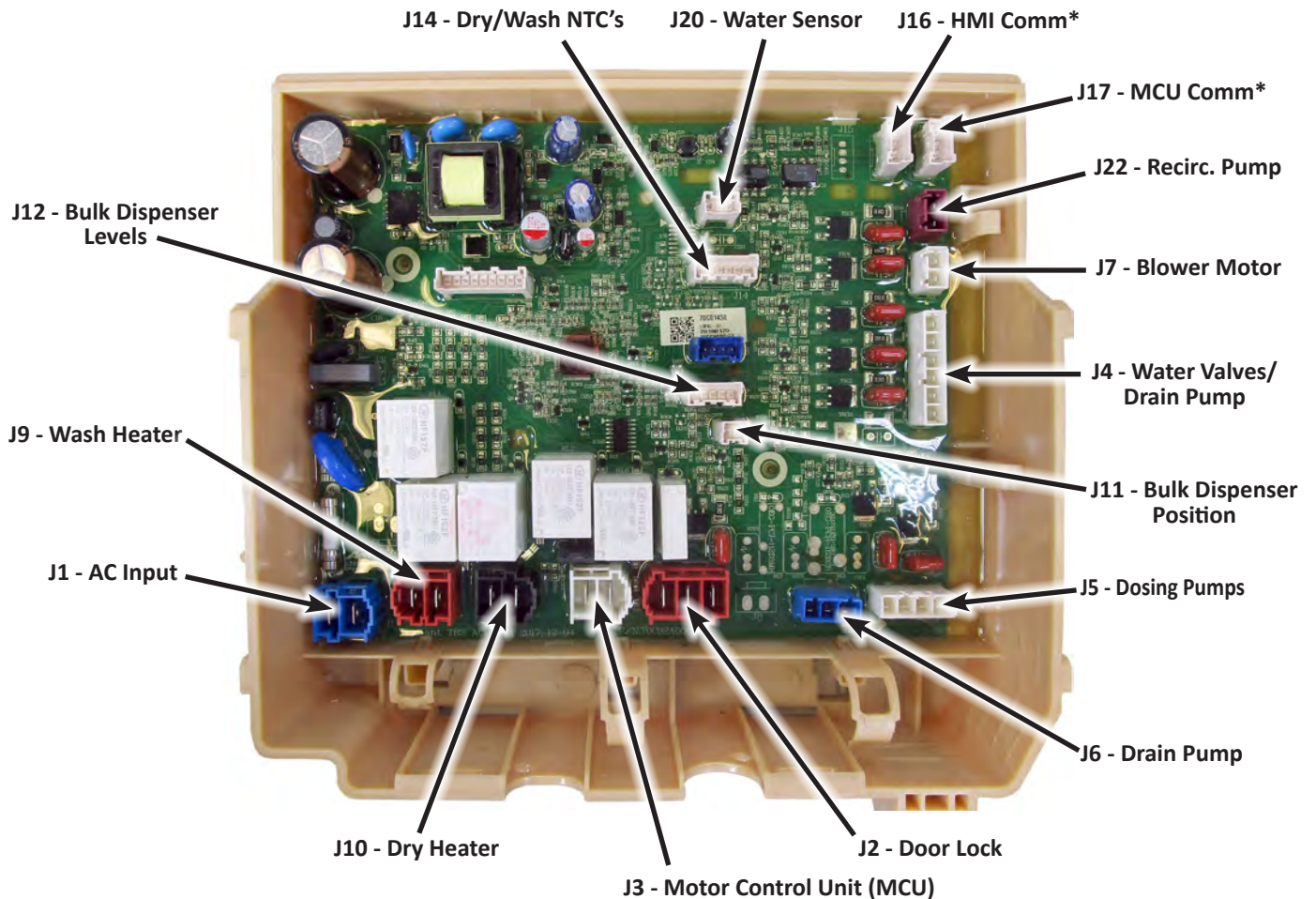

ACU CONNECTOR PIN-OUTS

J1	AC INPUT (BL)	J6	DRAIN PUMPS (BL)	J14	DRY & WASH NTC'S (WT)
J1-1	L2	J6-1	Open	J14-1	Dry NTC
J1-2	L1	J6-2	Mains relay out (L1)	J14-2	+5V
J2	DOOR LOCK (RD)	J6-3	Open	J14-3	Open
J2-1	L1 switched by door lock	J7	BLOWER MOTOR (WT)	J14-4	Open
J2-2	L1 switched by main relay	J7-1	Blower motor (L2)	J14-5	Wash NTC
J2-3	Door lock/unlock (L2)	J7-2	Mains relay out (L1)	J14-6	+5V
J3	DOOR LOCK TO DD MOTOR (WH)	J9	WASH HEATER (RD)	J16	HMI CONNECTOR (WT)
J3-1	L1 switched by door lock	J9-1	Wash Heater (L2)	J16-1	ISO +5V
J3-2	L2	J9-2	Wash Heater (L1)	J16-2	OPTO WIN
J4	WATER VALVES (WT)	J10	DRY HEATER (BK)	J16-3	ISO GND
J4-1	Mains relay out (switched L1)	J10-1	Dry Heater (L2)	J16-4	ISO +12.7V
J4-2	Open	J10-2	Dry Heater (L1)	J17	MCU CONNECTOR (WT)
J4-3	Open	J11	BULK DISP. POS. (WT)	J17-1	ISO +5V
J4-4	Condensation valve (L2)	J11-1	+5 VDC Out	J17-2	OPTO WIN
J4-5	Drain pump (L2)	J11-2	Drawer Position	J17-3	ISO GND
J4-6	Main wash valve (L2)	J12	BULK DISP. LEVELS (WT)	J17-4	ISO +12.7V
J5	DOSING PUMPS (WH)	J12-1	ADS Feedback Detergent	J20	WATER SENSOR (WT)
J5-1	Detergent pump (L2)	J12-2	Switched 5V	J20-1	GND
J5-2	Mains relay out (L1)	J12-3	ADS Feedback Softener	J20-2	APS Input
J5-3	Mains relay out (L1)	J12-4	Switched 5V	J20-3	+5V
J5-4	Softener pump (L2)	J12-5	Open	J22	RECIRCULATION PUMP (BR)
				J22-1	Mains relay out (L1)
				J22-2	Recirculation pump (L2)

For Service Technician Use Only

⚠ WARNING



Electrical Shock Hazard

Disconnect power before servicing.

Replace all parts and panels before operating.

Failure to do so can result in death or electrical shock.

TEST #2: Human-Machine Interface (HMI)

This test is performed when any of the following situations occurs during the Service Diagnostic Mode Tests (see page 2-3): display does not turn on and/or no sound is heard.

1. Unplug washer or disconnect power.
2. Gently lay washer/dryer on its right side to access the ACU. Remove AC shield and ACU cover.
3. Visually check that all ACU connectors are inserted all the way into the ACU. See Figure 2, page 3-5.
4. Visually check that all HMI connectors are inserted all the way into the HMI (see Figure 2 below).
5. If all visual checks pass, perform TEST #1: ACU Power Check, page 3-4, to verify supply voltage and health of micro-controller.
 - If supply voltages are present and micro-controller is functioning properly, replace the HMI and housing assembly.
 - If supply voltages are not present, replace the ACU.
6. Reassemble all parts and panels.
7. Plug in washer/dryer or reconnect power.
8. Perform the Service Diagnostic Mode Tests on page 2-3 to verify repair.

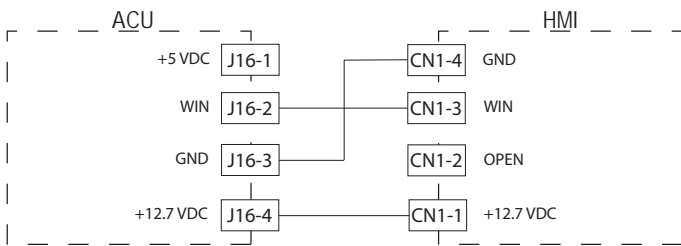

Figure 1 - Human-Machine Interface (HMI) Strip Circuit

HUMAN-MACHINE INTERFACE (HMI)

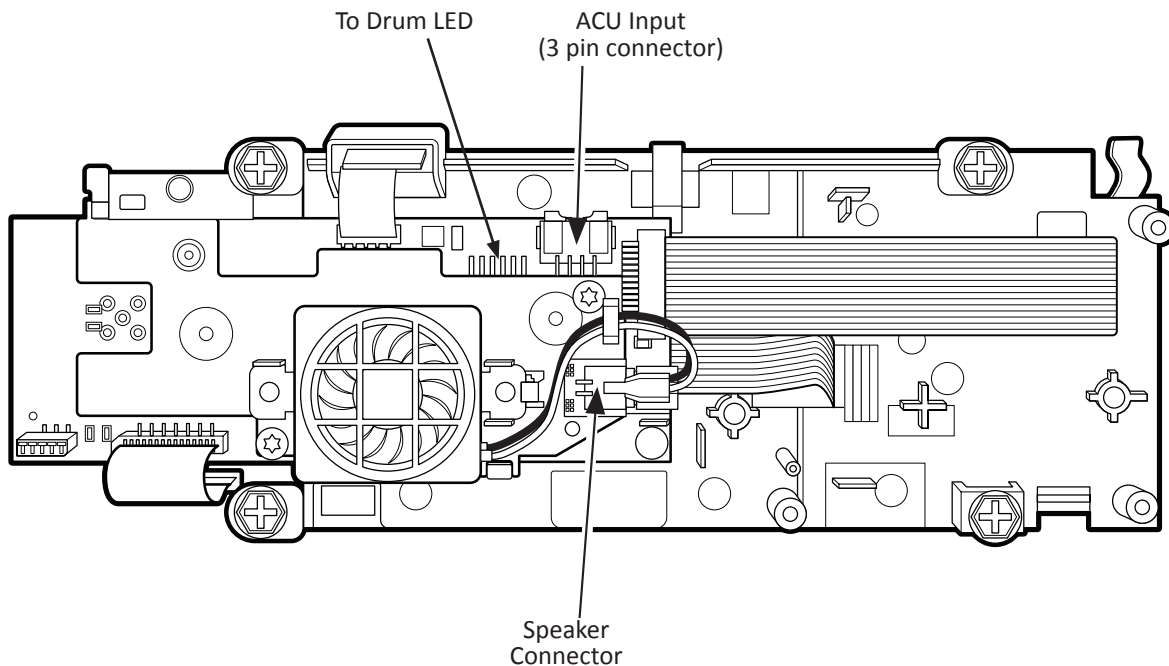



Figure 2 - Connector Locations on HMI

For Service Technician Use Only

⚠ **WARNING**



Electrical Shock Hazard

Disconnect power before servicing.

Replace all parts and panels before operating.

Failure to do so can result in death or electrical shock.

TEST #3: Motor Circuit

This test checks the motor, ACU, and wiring.

1. Check the motor and electrical connections by performing the Service Diagnostic Mode Tests on page 2-3. **IMPORTANT:** Door must be closed and locked to run motor. The following steps assume that this step was unsuccessful.
2. Unplug washer/dryer or disconnect power.
3. Check to see if basket will turn freely.
 - If basket turns freely, go to step 4.
 - If basket does not turn freely, determine what is causing the mechanical friction or lockup.
4. Gently lay washer/dryer on its right side to access the ACU and MCU. Remove AC shield, ACU cover, and MCU cover.
5. Visually check that connectors **J3** and **J17** are inserted all the way into the ACU.
 - If visual checks pass, go to step 6.
 - If visual checks fail, reconnect **J3** and **J17**, set unit upright and repeat step 1.
6. Visually check that MCU connectors **J2A**, **J3**, and **J4A** are inserted all the way into the MCU (see Figure 1).
 - If visual checks pass, go to step 7.
 - If visual checks fail, reconnect **J2A**, **J3**, and **J4A**, set unit upright and repeat step 1.
7. Check the motor windings. Disconnect the motor harness **J4A** from the MCU (see Figure 2). With an ohmmeter, verify the resistance values as shown in following table:

Motor Harness	Windings
J4A, Pins 1 & 2	6-20 Ω
J4A, Pins 2 & 3	6-20 Ω
J4A, Pins 1 & 3	6-20 Ω

 - If the values are outside the range or open, replace stator assembly and retest; otherwise, reconnect the motor harness J4A to MCU and go to step 8.
8. Check harness continuity between ACU-J3 to MCU-J2A, and ACU-J17 to MCU-J3.
 - If any harness fails the continuity check, replace harness and retest. Otherwise, reconnect harnesses and go to step 9.
9. Plug in washer/dryer or reconnect power.
10. Run the Service Diagnostic Mode Tests on page 2-3. **IMPORTANT:** Door must be closed and locked to run motor.
11. The motor should be powered and moving. If it is not, replace the MCU.
12. If the preceding steps did not correct the motor problem, replace the ACU.
 - Unplug washer/dryer or disconnect power.
 - Replace the ACU.
 - Reassemble all parts and panels.
 - Perform the Service Diagnostic Mode Tests on page 2-3 to verify repair.

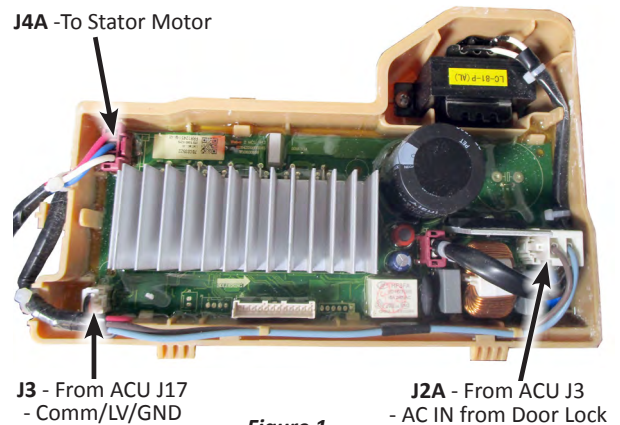

Figure 1

MOTOR

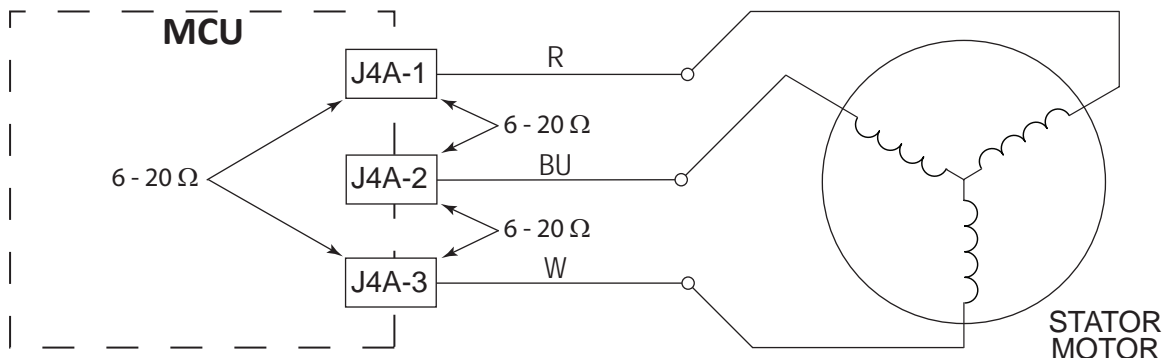



Figure 2 - Direct Drive Motor Strip Circuit

For Service Technician Use Only

⚠ WARNING



Electrical Shock Hazard

Disconnect power before servicing.

Replace all parts and panels before operating.

Failure to do so can result in death or electrical shock.

5. Disconnect the **J2** connector from the ACU. **NOTE:** To measure the door lock switch in the “locked” position, plug in washer/dryer or reconnect power. Press the **POWER** button, select any cycle, and then press **START**. Actuation of the door lock solenoid should be heard. At that point, unplug the washer/dryer and disconnect **J2** from the ACU and measure resistance across pins (ACU side) according to the following chart:

Component	Resistance	Contacts Measured	
Door Switch	Door Open = Open Circuit Door Closed = ~170 ohms	J2-2	J2-3
Lock Switch	Locked = 0 ohms Unlocked = Open Circuit	J2-1	J2-2
Lock Solenoid	~170 ohms with door closed	J2-2	J2-3

TEST #4: Door Lock System

Check the relays and electrical connections to the door lock by performing the Service Diagnostic Mode Tests on page 2-3. The following steps assume the door cannot lock or unlock during that test. Perform the following checks if the washer does not lock (or unlock).

1. Check door lock mechanism for obstruction or binding. Repair as necessary.
2. Unplug washer/dryer or disconnect power.
3. Gently lay washer/dryer on its right side to access the ACU. Remove AC shield and ACU cover.
4. Visually check that the **J2** (door switch) connector is inserted all the way into the ACU.
 - If visual check passes, go to step 5.
 - If any of the connectors are not inserted properly, reconnect and retest door lock.
5. Disconnect the **J2** connector from the ACU. **NOTE:** To measure the door lock switch in the “locked” position, plug in washer/dryer or reconnect power. Press the **POWER** button, select any cycle, and then press **START**. Actuation of the door lock solenoid should be heard. At that point, unplug the washer/dryer and disconnect **J2** from the ACU and measure resistance across pins (ACU side) according to the following chart:
 - If resistance values are good, go to step 6.
 - If any of the measurements are out of range, check the harness of the suspected component between the ACU and door lock mechanism for continuity.
 - If the harness and connections are good, replace the door lock mechanism. **IMPORTANT:** To minimize risk of damage to door lock/switch wires, remove the door lock mechanism screws before removing the front panel.
6. If the preceding steps did not correct the lock problem, replace the ACU and retest door lock mechanism.
 - Unplug washer/dryer or disconnect power.
 - Replace the ACU.
 - Reassemble all parts and panels.
 - Perform the Service Diagnostic Mode Tests on page 2-3 to verify repair.

DOOR LOCK SYSTEM

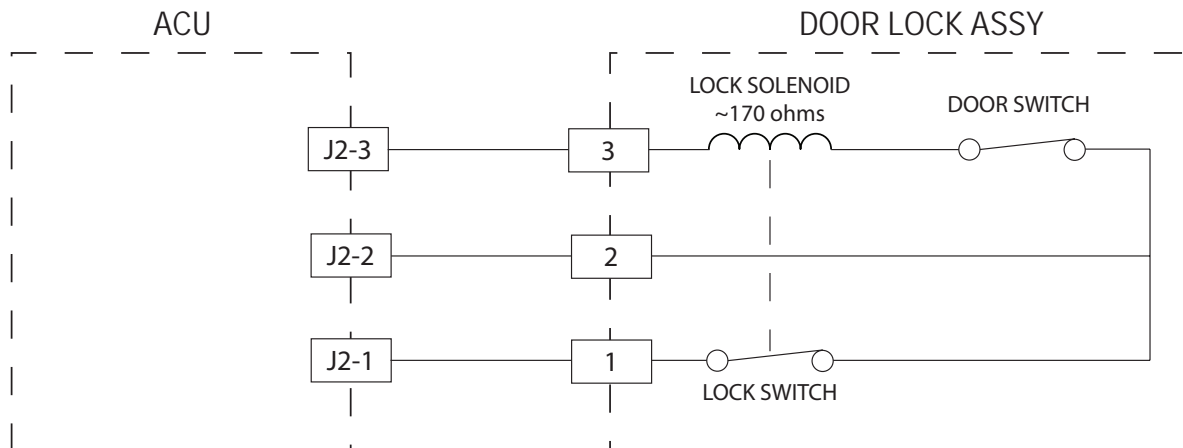



Figure 1 - Door Lock Strip Circuit

For Service Technician Use Only

⚠ DANGER



Electrical Shock Hazard

Only authorized technicians should perform diagnostic voltage measurements.

After performing voltage measurements, disconnect power before servicing.

Failure to follow these instructions can result in death or electrical shock.

TEST #5: Inlet Valve

This test checks the electrical connections to the valve and the valve itself. The inlet valve is a double valve consisting of a main fill and condenser valve.

1. Check the relays and electrical connections to the valve by performing the Service Diagnostic Mode Tests on page 2-3. The following steps assume one or more of the valves did not turn on.
2. For the valve(s) in question, check the individual solenoid coils:
 - a. Unplug washer/dryer or disconnect power.
 - b. Remove top panel to access the inlet valve, and then gently lay washer/dryer on its right side to access the ACU. Remove AC shield and ACU cover.
 - c. Remove connector **J4** from the ACU. Refer to ACU diagram on page 3-5.
 - d. Check harness connections to the solenoid valves. Verify continuity in harness between ACU and solenoid valves.

3. Check valve coil resistance at the valve, or across the following connector pinouts:

Valve	Pinout
Main Fill Valve	J4, pins 1 & 6
Condenser Valve	J4, pins 1 & 4

Resistance should be 890 - 1.1k Ω .

- If resistance readings are outside the range or open, replace the valve assembly.
 - If resistance readings are within range, reconnect **J4**. Go to step 4.
4. Plug in washer/dryer or reconnect power.
 5. With a voltmeter set to **AC**, attach the leads across the pins of the suspect valve (see chart in step 3). Run the Service Diagnostic Mode Tests and check for line voltage across the pins of the valve. **NOTE:** Refer to the Service Diagnostic Mode Tests on page 2-3 to determine when the main fill and condenser valves are actuated.
 - If line voltage is present and valve still does not activate, replace valve assembly.
 - If line voltage is not present, replace the ACU.
 6. Unplug washer/dryer or disconnect power.
 7. Reassemble all parts and panels.
 8. Perform the Service Diagnostic Mode Tests on page 2-3 to verify repairs.

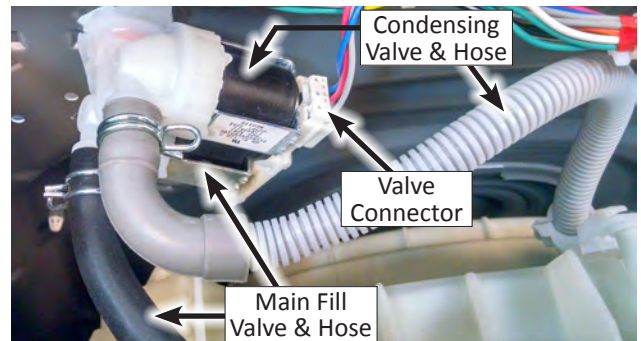

Figure 1 - Inlet Valve

INLET VALVE ASSEMBLY

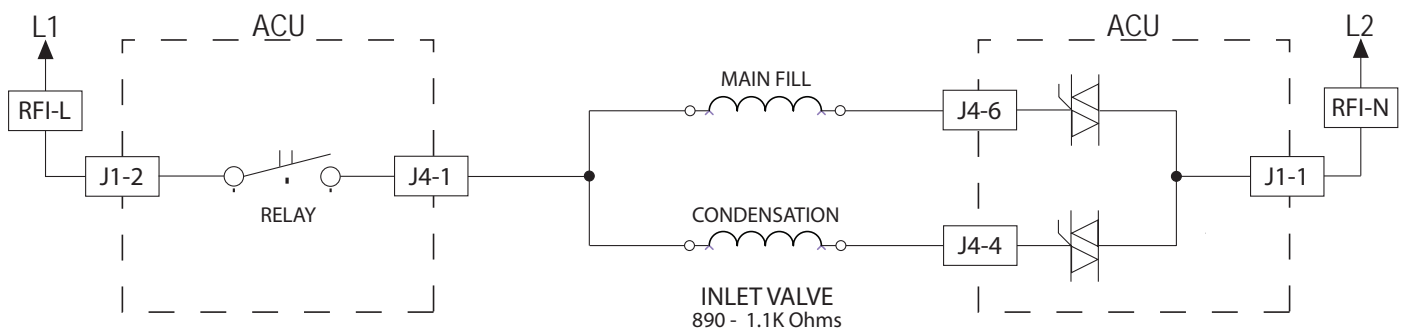



Figure 2 - Inlet Valve Strip Circuit

For Service Technician Use Only

⚠ DANGER



Electrical Shock Hazard

Only authorized technicians should perform diagnostic voltage measurements.

After performing voltage measurements, disconnect power before servicing.

Failure to follow these instructions can result in death or electrical shock.

8. Check hose for leaks. Replace if needed.
9. Gently lay washer/dryer on its right side to access the ACU. Remove AC shield and ACU cover.
10. Visually check that connector **J20** is inserted all the way into the ACU. Also check that the pressure switch harness is securely connected to the switch.
11. Check the harness between the ACU and pressure switch for continuity.
 - If there is continuity, go to step 12.
 - If there is no continuity, repair or replace as necessary.
12. Plug in washer/dryer or reconnect power.
13. With a voltmeter set to **DC**, connect black probe to ACU connector **J20**, pin 1 (GND) and red probe to **J20**, pin 3 (+5V [Vcc]).
 - If +5V DC is present, replace the pressure switch. (Before replacing the switch, make sure that there is NO water remaining in the tub or there will not be an accurate water level measurement and an error code may appear. Drain the tub by running a drain & spin cycle with the switch plugged into **J20** but with the hose removed).
 - If +5V DC is not present, perform TEST #1: ACU Power Check on page 3-4.
14. If the preceding steps did not correct the problem, replace the ACU.
 - Unplug washer/dryer or disconnect power.
 - Replace the ACU.
 - Reassemble all parts and panels.
 - Perform the Service Diagnostic Mode Tests on page 2-3 to verify repair.

TEST #6: Pressure Switch

This test checks the pressure switch, ACU, and wiring. **NOTE:** Usually, if the pressure switch malfunctions, the washer will generate a water level sensor error (F3E1).

1. Check the functionality of the water level sensor by running a small load cycle. The valve should turn off automatically after sensing the correct water level in the tub. The following steps assume that this step was unsuccessful.
2. Press **START/PAUSE** to stop the cycle and then press **POWER**. The cycle will cancel and drain the water from the tub.
3. Unplug washer/dryer or disconnect power.
4. Remove top panel to access tub, air trap, and pressure hose connections. Pressure switch is located at top right front of cabinet.
5. Check connections from tub to air trap, air trap to pressure hose, and pressure hose to pressure switch.
6. Check to ensure hose is routed correctly in the lower cabinet and not pinched or crimped.
7. Verify there is no water, suds, or debris in the hose or air trap. Disconnect hose from pressure switch, clean air trap and remove and blow into hose to clear water, suds, or debris.

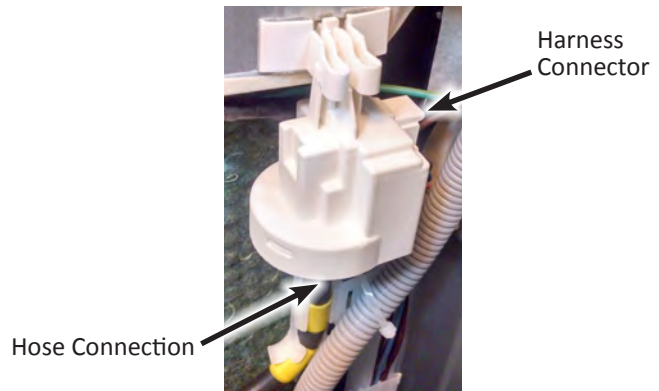

Figure 1 - Pressure Switch

PRESSURE SWITCH

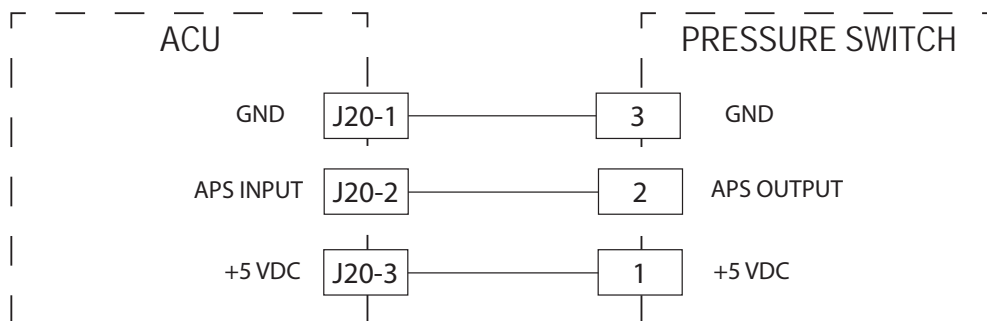



Figure 2 - Pressure Switch

For Service Technician Use Only

⚠ WARNING



Electrical Shock Hazard

Disconnect power before servicing.

Replace all parts and panels before operating.

Failure to do so can result in death or electrical shock.

TEST #7: Drain/Recirculation Pump

Perform the following checks if washer/dryer does not drain.

1. Check for obstructions in the usual areas. Clean and then perform step 2.
2. Check the pump and electrical connections by performing the Service Diagnostic Mode Tests on page 2-3. The following procedures assume that this step was unsuccessful.
3. Unplug washer/dryer or disconnect power.
4. Gently lay washer/dryer on its right side to access the ACU. Remove AC shield and ACU cover.
5. Visually check that the **J4**, **J6**, and/or **J22** connector is inserted all the way into the ACU.
 - If visual check passes, go to step 6.
 - If connectors are not inserted properly, reconnect **J4**, **J6**, and/or **J22** and repeat step 2.
6. **Drain Pump:** Remove connectors **J4** and **J6** from the ACU. With an ohmmeter, measure the resistance across J4, pin 5 and J6, pin 2. (Continue to step 7.)
Recirculation Pump: Remove connector **J22** from the ACU. With an ohmmeter, measure the resistance across J22, pin 1 and J22, pin 2. (Continue to step 7.)
7. Resistance should be: Drain Pump (**45–65 Ω**) and Recirculation Pump (**150–190 Ω**) when at room temperature.

- If the reading is infinite (open), go to step 8.
 - If the reading is correct, go to step 12.
8. Remove the rear panel to access drain & recirculation pump. Verify that pump, pump filter, drain hose, and air trap are free from obstructions.
 9. Visually check the electrical connections at the drain and recirculation pumps.
 - If visual check passes, go to step 10.
 - If connections are loose, reconnect the electrical connections and repeat step 2.
 10. With an ohmmeter, check harness for continuity between the pump assembly and ACU.
 - If there is continuity, go to step 11.
 - If there is no continuity, replace the lower machine harness and repeat step 2.
 11. With an ohmmeter, measure the resistance across the two drain and recirculation pump terminals. Resistance should be: Drain Pump (**45–65 Ω**) and Recirculation Pump (**150–190 Ω**).
 - If the reading is far out of range or open, replace the pump assembly.
 - If the reading is correct, go to step 12.
 12. If the preceding steps did not correct the drain or recirculation problem, replace the ACU.
 - Unplug washer/dryer or disconnect power.
 - Replace the ACU.
 - Reassemble all parts and panels.
 - Perform the Service Diagnostic Mode Tests on page 2-3 to verify repair.

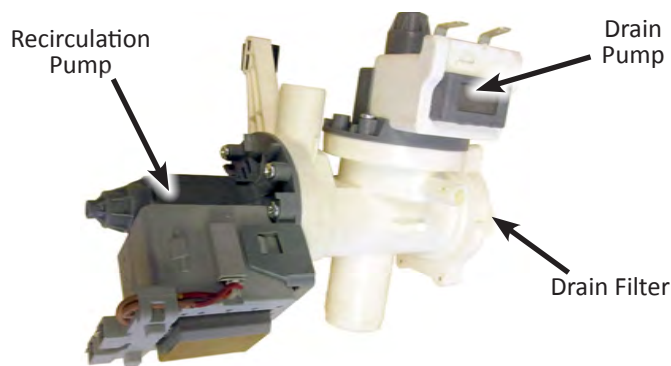

Figure 1 - Drain/Recirculation Pump

DRAIN/RECIRCULATION PUMP

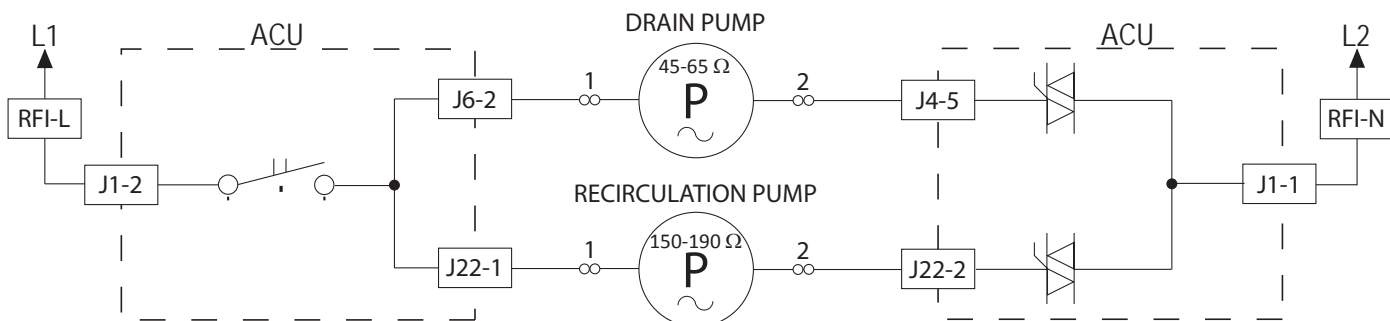



Figure 2 - Drain/Recirculation Pump Strip Circuit

COMPONENT TESTING

For Service Technician Use Only

⚠ **WARNING**



Electrical Shock Hazard

Disconnect power before servicing.

Replace all parts and panels before operating.

Failure to do so can result in death or electrical shock.

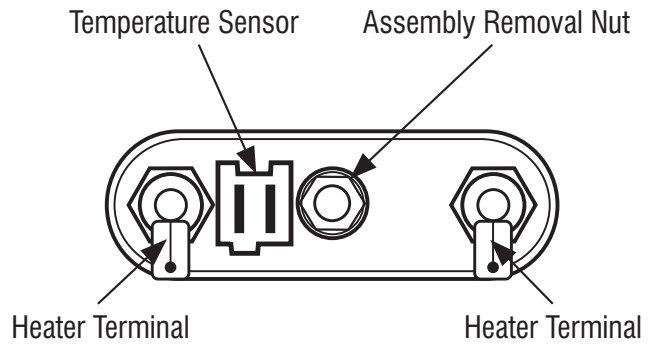

Figure 1 - Heating/Temperature Sensor Assembly

TEST #8: Wash Heating Element

This test checks the wash heating element, wiring, and ACU.

1. Unplug washer/dryer or disconnect power.
2. Gently lay washer/dryer on its right side to access the ACU. Remove AC shield and ACU cover.
3. Disconnect connector **J9** from the ACU.
4. Using an ohmmeter, measure the resistance across pins 1 and 2 of connector **J9**.
 - If the resistance is **30–34 Ω**, the heating element and wiring are good; go to step 8.
 - If the resistance is open, go to step 5.
5. Lay down washer/dryer and remove rear panel to access the heating element.
6. Disconnect the wire connectors from the heating element. See Figure 1.
7. Using an ohmmeter, measure the resistance across the two heating element terminals.
 - If the resistance is **30–34 Ω**, the heating element is good; replace the lower main harness.
 - If the resistance is open, or very much out of range, replace the heating element.

Wash Heater Connector (J9) on ACU

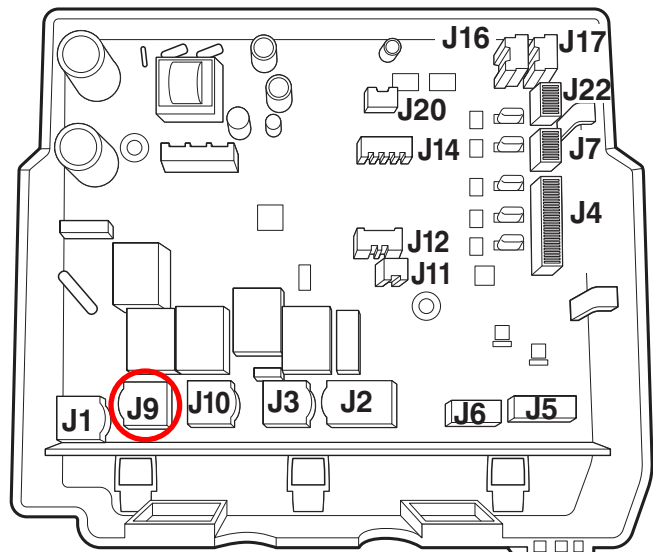

Figure 2 - Heater Connector Location on ACU

WASH HEATING ELEMENT

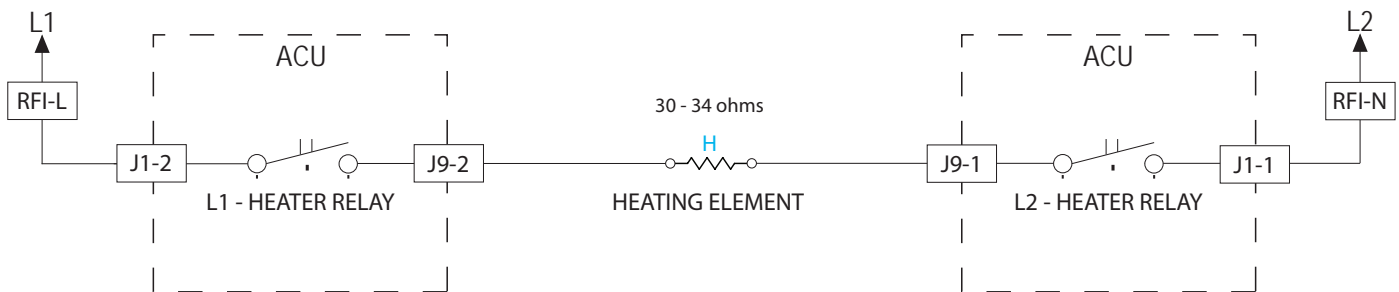



Figure 3 - Wash Heating Element Strip Circuit

For Service Technician Use Only

⚠ WARNING



Electrical Shock Hazard
Disconnect power before servicing.
Replace all parts and panels before operating.
Failure to do so can result in death or electrical shock.

THERMISTOR SENSOR RESISTANCE		
Approx. Temperature		Approx. Resistance
140	60	4.9
158	70	3.4
176	80	2.4
194	90	1.8
212	100	1.3
248	120	0.7
302	150	0.3

- If the resistance is infinite or close to zero, go to step 5.
 - If it is within range, go to step 8.
5. Remove the rear panel to access the wash heating element.
 6. Disconnect the wash temperature sensor connector from the heating element. See Figure 1.
 7. Using an ohmmeter, measure the resistance across pins 1 and 2 of the wash temperature sensor (on the heating element).
 - If the resistance is within the specified range, the sensor is good; replace the main harness.
 - If the resistance is far out of range or open, replace the temperature sensor.
 8. If the preceding steps did not correct the temperature sensor problem, replace the ACU.
 - Unplug washer/dryer or disconnect power.
 - Replace the ACU.
 - Reassemble all parts and panels.
 - Perform the Service Diagnostic Mode Tests on page 2-3 to verify repair.

TEST #9: Wash Temperature Sensor

This test checks the temperature sensor, wiring, and ACU. This test checks the temperature sensor, wiring, and ACU.

1. Unplug washer/dryer or disconnect power.
2. Gently lay washer/dryer on its right side to access the ACU. Remove AC shield and ACU cover.
3. Disconnect connector **J14** from the ACU.
4. Using an ohmmeter, measure the resistance across pins 5 and 6 of temperature sensor connector **J14**.

THERMISTOR SENSOR RESISTANCE		
Approx. Temperature		Approx. Resistance
F°	C°	(KΩ)
-4	-20	197.3
14	-10	111.6
32	0	65.5
59	15	31.5
77	25	20.0
86	30	16.1
104	40	10.6
122	50	7.1

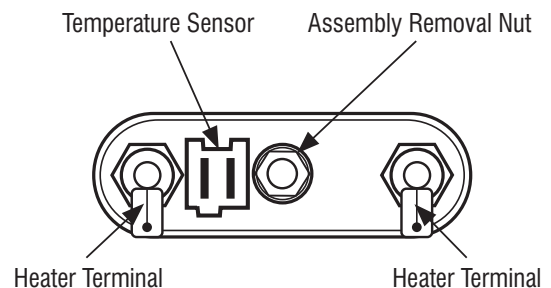

Figure 1 - Temperature Sensor

WASH TEMPERATURE SENSOR

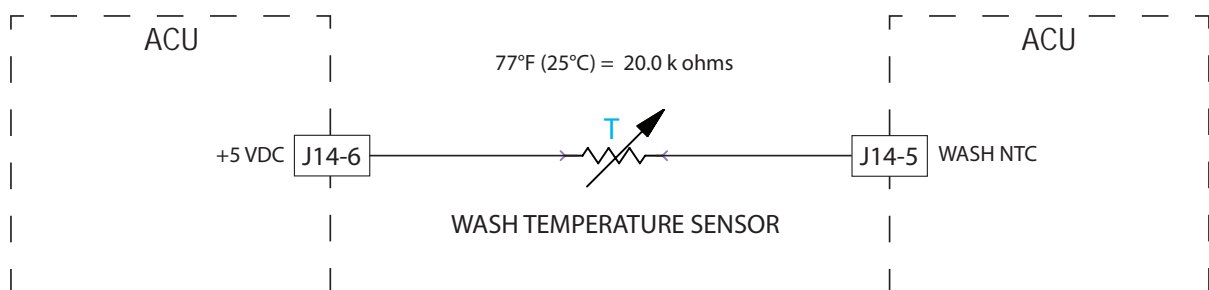



Figure 2 - Wash Temperature Sensor Strip Circuit

For Service Technician Use Only

⚠ WARNING



Electrical Shock Hazard

Disconnect power before servicing.

Replace all parts and panels before operating.

Failure to do so can result in death or electrical shock.

- If visual check passes, go to step 6.
 - If connector is not inserted properly, reconnect J11 and verify that the container is detected.
6. Disconnect **J11** from ACU. Using an ohmmeter, connect leads across pins 1 and 2 of J11. With the bulk container removed, the reed switch should read open.

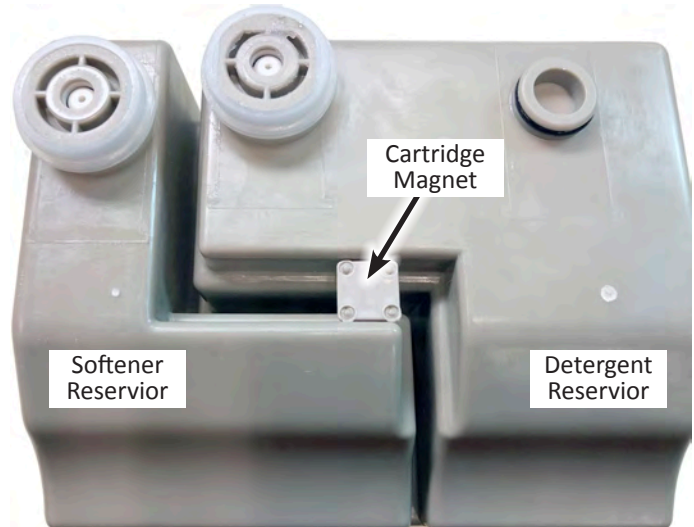

Figure 1 - Dispenser Container Bottom View

TEST #10a: Dispenser Sensing

Bulk Dispenser Container not Detected

Perform the following checks if the washer cannot detect the presence of the container in the dispenser assembly.

1. Verify that the bulk dispenser container is fully seated in the dispenser cavity on the top of the washer/dryer. Close the bulk dispenser lid.
 - If container is not detected, go to step 2.
 - If container is detected, go to step 8.
2. Open dispenser lid and remove bulk dispenser container. Verify that magnet is in place under the container (see Figure 1).
 - If magnet is present, go to step 3.
 - If magnet is not present, replace the bulk dispenser container assembly.
3. Unplug washer/dryer or disconnect power.
4. Gently lay washer/dryer on its right side to access the ACU. Remove AC shield and ACU cover.
5. Visually check that the **J11** connector is inserted all the way into the ACU.

7. Next, place a magnet in the center of the floor of the bulk dispenser cavity, near the approximately location of the magnet location in Figure 1. The magnet should close the reed switch (less than 3 ohms).
 - If the resistance still reads open, replace the entire bulk dispenser assembly. (Other than the container, the dispenser assembly is not serviceable.)
 - If the preceding steps did not correct the problem, replace the ACU.
8. Unplug washer/dryer or disconnect power.
9. Reassemble all parts and panels.
10. Perform the Service Diagnostic Mode Tests on page 2-3 to verify repairs.

Continue to next page for "Detergent/Softener not Detected"...

DISPENSER SENSING

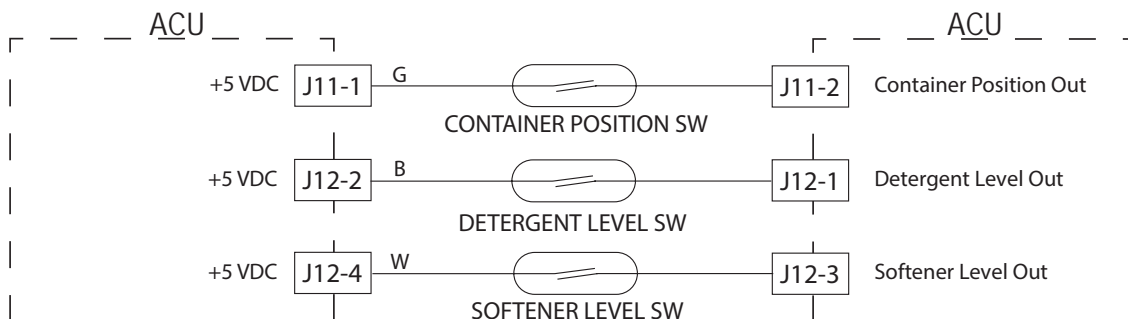

Figure 2 - Detergent Sensing Strip Circuit

For Service Technician Use Only

Detergent/Softener Level not Detected

Perform the following checks if the washer cannot detect the level of the detergent or softener in the reservoir.

1. Open dispenser lid on top the washer/dryer and remove the bulk dispenser container. Remove both the detergent and softener filters and clean thoroughly with warm water. Reinstall both filters.
2. Reinsert bulk dispenser container and verify it is fully seated in the dispenser cavity. Close the bulk dispenser lid and retest.
 - If detergent/softener level is not detected, go to step 3.
 - If detergent/softener level is detected, go to step 11.
3. Open dispenser lid and remove bulk dispenser container. Save customer's detergent and softener in spare container(s). When empty, you should 'hear' the floats moving up and down when the container is rotated (see Figure 3). If stuck, thoroughly rinse both container reservoirs with warm water. Fill reservoirs with water to test floats. Reinstall bulk dispenser container in dispenser assembly and check for proper operation.

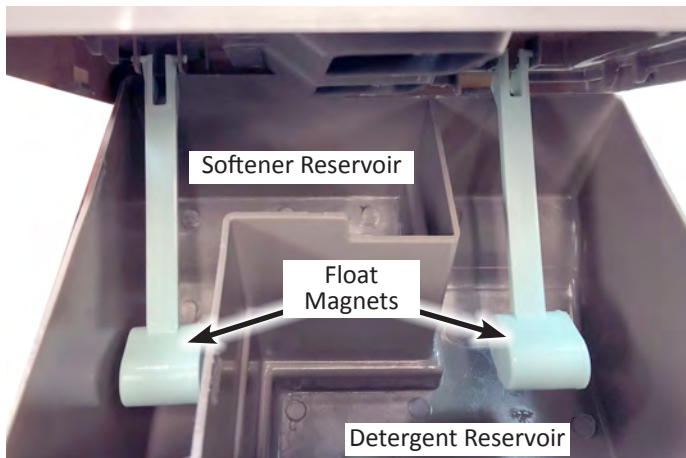

Figure 3 - Dispenser Container Inside View

- If floats are damaged, replace the entire bulk dispenser container. Container is not serviceable.
 - If floats are working, but detergent/softener level is not detected, go to step 4.
4. Unplug washer/dryer or disconnect power.
 5. Gently lay washer/dryer on its right side to access the ACU. Remove AC shield and ACU cover.
 6. Visually check that the **J12** connector is inserted all the way into the ACU.
 - If visual check passes, go to step 7.
 - If connector is not inserted properly, reconnect **J12** and retest.
 7. To test the **detergent level switch**, disconnect **J12** from ACU. Using an ohmmeter, connect leads across pins **1** and **2** of connector **J12**. With the bulk container removed, the reed switch should read open.
 8. While watching the ohmmeter, move a magnet around the floor of the bulk dispenser cavity (front for detergent). The magnet should close the reed switch (less than 3 ohms).
 - If the resistance still reads open, replace the entire bulk dispenser assembly.
 9. To test the **softener level switch**, using an ohmmeter, connect leads across pins **3** and **4** of connector **J12**. With the bulk container removed, the reed switch should read open.
 10. While watching the ohmmeter, move a magnet around the floor of the bulk dispenser cavity (rear for softener). The magnet should close the reed switch (less than 3 ohms).
 - If the resistance still reads open, replace the entire bulk dispenser assembly.
 - If the preceding steps did not correct the problem, replace the ACU.
 11. Unplug washer/dryer or disconnect power.
 12. Reassemble all parts and panels.
 13. Perform the Service Diagnostic Mode Tests on page 2-3 to verify repairs.

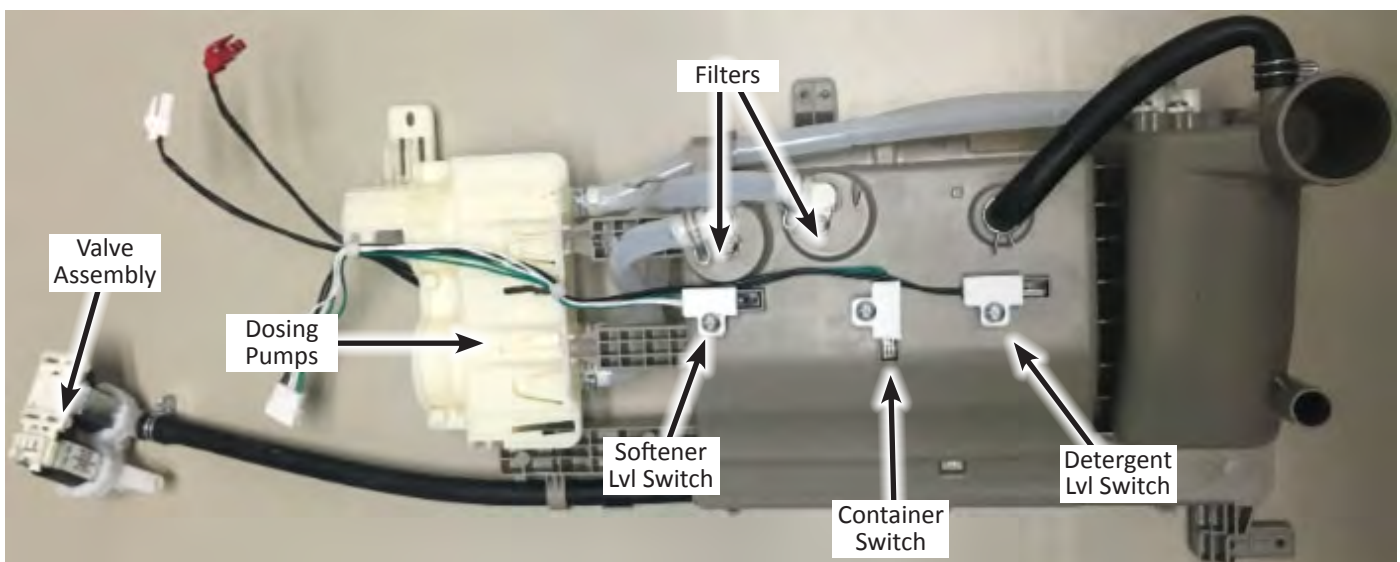



Figure 4 - Detergent Assembly - Bottom View

For Service Technician Use Only

⚠ DANGER



Electrical Shock Hazard

Only authorized technicians should perform diagnostic voltage measurements.

After performing voltage measurements, disconnect power before servicing.

Failure to follow these instructions can result in death or electrical shock.

TEST #10b: Dispenser Metering Pumps

Perform the following checks if the washer will not dispense detergent or fabric softener.

1. Check water supply to washer. Check water hose connections to and inside the washer.
2. Verify that bulk dispenser reservoir is not clogged with detergent or fabric softener.
3. Remove bulk container and make sure the two filters are in place at the base of the reservoir.
4. Check the relays and electrical connections to the dosing pumps by performing the Service Diagnostic Mode Tests on page 2-3. The following steps assume the detergent and/or fabric softener pump did not turn on.
5. Unplug washer/dryer or disconnect power.
6. Remove bulk container. Remove bulk dispenser lid by removing six screw cap covers and six screws.
7. Remove the top panel to access the dispenser system
8. Plug in washer/dryer or reconnect power.
9. Actuate each metering pump by performing the Service Diagnostic Mode Tests on page 2-3.

Pump 1 (detergent pump)—detergent should dispense from the side bottom port; touch the top of the pump and feel for vibration/activation.

Pump 2 (fabric softener pump)—fabric softener should dispense from the side top port; touch the top of the pump and feel for vibration/activation.

- If pumps are actuating, but nothing is being dispensed, remove the bulk dispenser assembly and check if hoses are kinked or clogged.
 - If pumps are not actuating, go to step 10.
10. With a voltmeter set to **AC**, attach the leads across the pins of the suspect pump. Run the Service Diagnostic Mode Tests and check for line voltage across the pins of the pump. **NOTE:** Refer to the Service Diagnostic Mode Tests on page 2-3 to determine when the detergent and fabric softener pumps are actuated.
 - If line voltage is present and pump still does not activate, replace metering pump assembly.
 - If line voltage is not present, replace the ACU.
 11. Unplug washer/dryer or disconnect power.
 12. Reassemble all parts and panels.
 13. Perform the Service Diagnostic Mode Tests on page 2-3 to verify repairs.

Bulk Dispensing System & Metering Pumps

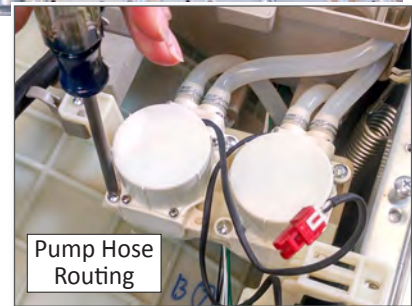
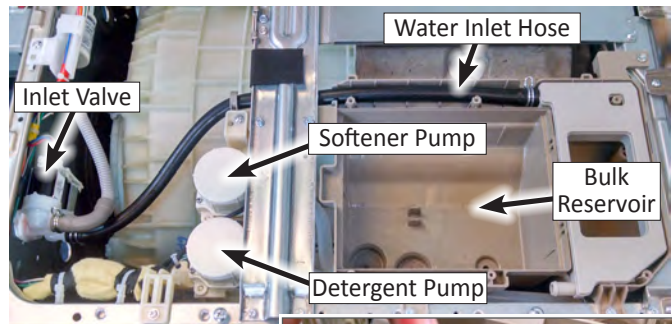

Figures 1 & 2 - Bulk Dispensing System & Metering Pumps

METERING PUMPS

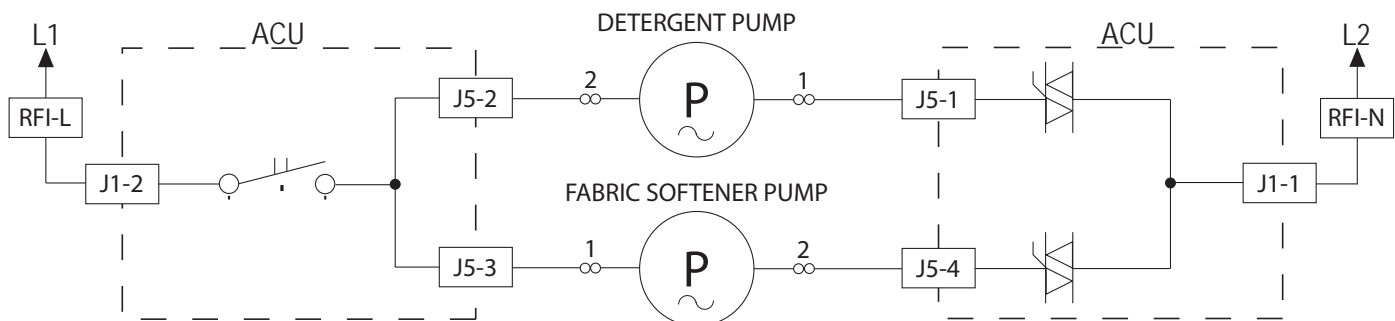



Figure 3 - Detergent & Fabric Softener Metering Pumps Strip Circuit

For Service Technician Use Only

⚠ WARNING



Electrical Shock Hazard
Disconnect power before servicing.
Replace all parts and panels before operating.
Failure to do so can result in death or electrical shock.

TEST #11: Supply Connections—U.S.

This test assumes that proper voltage is present at the outlet, and a visual inspection indicates that the power cord is securely fastened to the terminal block.

U.S. Installations:

1. Unplug washer/dryer or disconnect power.
2. Remove the terminal block cover from the back of the washer/dryer. See figure 1.

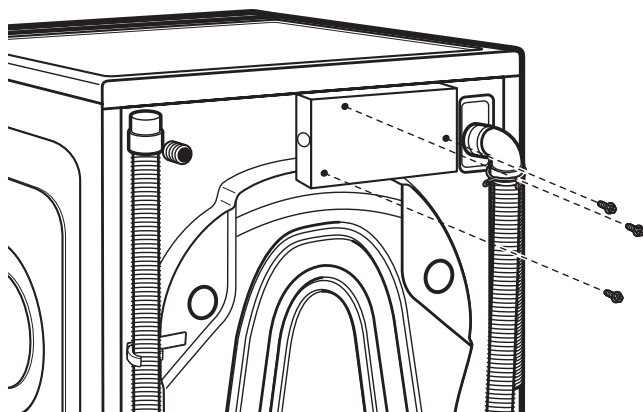

Figure 1 - Remove the cover plate.

3. With an ohmmeter, check for continuity between the neutral (N) terminal of the plug and the center contact on the terminal block. See figure 2.
 - If there is no continuity, replace the power cord and test the washer/dryer.
 - If there is continuity, go to step 4.
4. In a similar way, check which terminal of the plug is connected to the top contact on the terminal block and make a note of it. This will be L1 in the wiring diagram. Follow the same procedure for L2. See figure 2.
 - When this is found, go to step 5.
 - If neither of the plug terminals have continuity with the top contact of the terminal block, replace the power cord and retest washer/dryer.

Power Cord Plug

Terminal Block

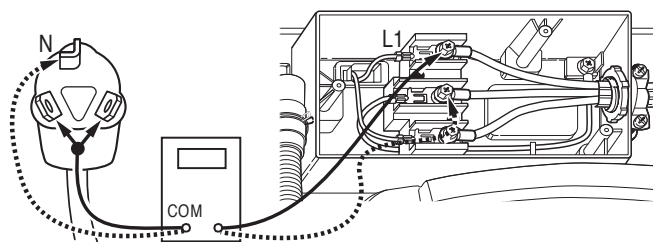



Figure 2 - Plug-to-terminal connections for electric dryer.

5. Gently lay washer/dryer on its right side to access the ACU. Remove AC shield and ACU cover. Access the machine electronics without disconnecting any wiring to the ACU.
6. Check for continuity between the L2 terminal of the plug and J1 on the ACU.
 - If there is continuity, go to step 7.
 - If there is no continuity, and the mechanical connections of the wire are secure, check for continuity at the IF – RFI. If there is no continuity, replace the harness between the ACU and the IF – RFI and the IF – RFI itself.
7. Visually check that ALL connectors are fully inserted into the ACU.
8. Visually check that ALL connectors are fully inserted into the HMI.
9. Reassemble all parts and panels.
10. Plug in washer/dryer or reconnect power.
11. Perform the Service Diagnostic Mode Tests on page 2-3 to verify repair.

Continue to next page for Canadian Installations . . .

For Service Technician Use Only

⚠ WARNING



Electrical Shock Hazard
Disconnect power before servicing.
Replace all parts and panels before operating.
Failure to do so can result in death or electrical shock.

4. If it is necessary to replace the power cord, remove the retaining clip that secures the cord to the back panel. Disconnect the cord from the main harness and the ground wire from the rear panel, then pull out the power cord.
5. Visually check that ALL connectors are fully inserted into the ACU.
6. Visually check that ALL connectors are fully inserted into the HMI.
7. Reassemble all parts and panels.
8. Plug in washer/dryer or reconnect power.
9. Perform the Service Diagnostic Mode Tests on page 2-3 to verify repair.

TEST #11: Supply Connections—CAN

This test assumes that proper voltage is present at the outlet, and a visual inspection indicates that the power cord is securely fastened to the terminal block.

Canadian Installations:

1. Unplug washer/dryer or disconnect power.
2. Gently lay washer/dryer on its right side to access the ACU. Remove AC shield and ACU cover. Access the machine electronics without disconnecting any wiring to the ACU.
3. With an ohmmeter, check the continuity from L1 and L2 plug terminals of the power cord to the terminals for L1 and L2 on the ACU. See figure 1.

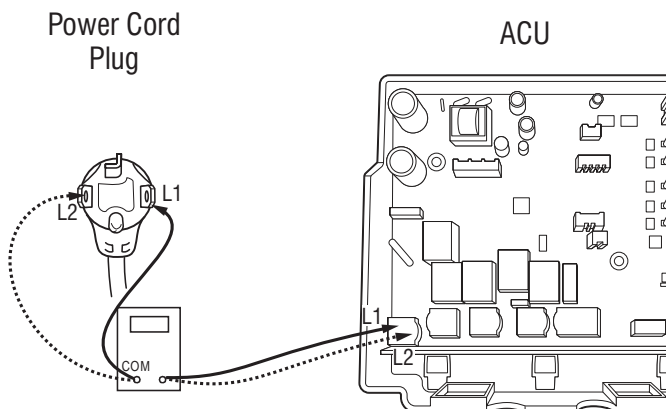



Figure 1 - Plug-to-terminal connections for electric dryer.

- If continuity exists for both connections, go to step 5.
- If an open circuit is found, check the integrity of the connections of the power cord to the harness in the washer/dryer; harness to the ACU; and the integrity of the power cord itself.

For Service Technician Use Only

⚠ WARNING



Electrical Shock Hazard

Disconnect power before servicing.

Replace all parts and panels before operating.

Failure to do so can result in death or electrical shock.

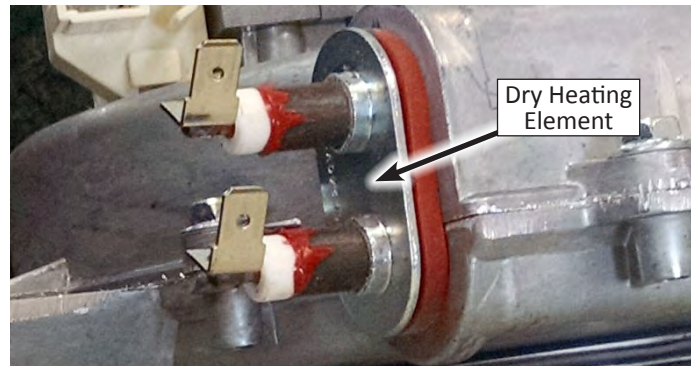

Figure 1 - Dry Heating Element

TEST #12a: Dry Heating Element

This test checks the dry heating element, wiring, and ACU.

1. Unplug washer/dryer or disconnect power.
2. Gently lay washer/dryer on its right side to access the ACU. Remove AC shield and ACU cover.
3. Disconnect connector **J10** from the ACU.
4. Using an ohmmeter, measure the resistance across pins 1 and 2 of connector **J10**.
 - If the resistance is **30–50 Ω**, the heating element and wiring are good; go to step 8.
 - If the resistance is open, go to step 5.
5. Remove top panel to access the dry heating element.
6. Disconnect the wire connectors from the dry heating element. See Figure 1.
7. Using an ohmmeter, measure the resistance across the two heating element terminals.
 - If the resistance is **30–50 Ω**, the dry heating element is good; go to step 8.
 - If the resistance is far out of range or open, replace the Heater Channel Assembly. **NOTE:** The heater element cannot be replaced separately from the Heater Channel Assembly.

8. Check thermal cutoffs.

- Check continuity of the thermal cutoff on the L1 side of the harness.
- Check continuity of the thermal cutoff on the L2 side of the harness.
- Each thermal cutoff has a “reset” button. If either thermal cutoff is open, and cannot be reset, replace the thermal cutoff (see Figure 2). **NOTE:** Apply thermal grease/paste when replacing thermal cutoff.

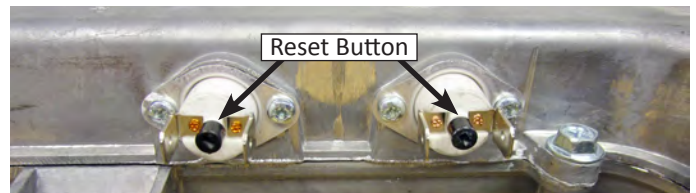

Figure 2 - Resettable Thermal Cutoffs (TCO's)

9. Check harness continuity between the **J10** on the ACU and the two thermal cutoffs.
 - If the harness shows open, replace main harness.
 - If harness continuity is good, go to step 10.
10. If the preceding steps did not correct the heating element problem, replace the ACU.
 - Unplug washer/dryer or disconnect power.
 - Replace the ACU.
 - Reassemble all parts and panels.
 - Perform the Service Diagnostic Mode Tests on page 2-3 to verify repair.

DRY HEATING ELEMENT

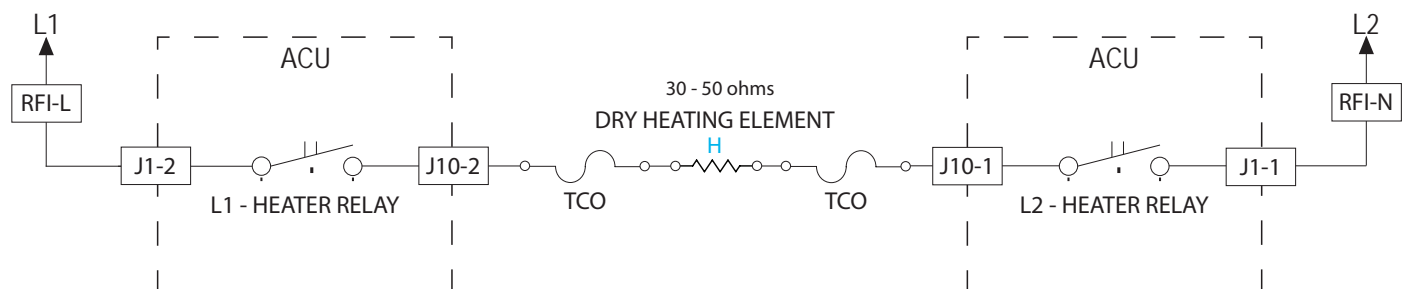

Figure 3 - Dry Heating Element Strip Circuit

For Service Technician Use Only

⚠ **WARNING**



Electrical Shock Hazard
Disconnect power before servicing.
Replace all parts and panels before operating.
Failure to do so can result in death or electrical shock.

THERMISTOR SENSOR RESISTANCE		
Approx. Temperature		Approx. Resistance
77	25	20.0
86	30	16.1
104	40	10.6
122	50	7.1
140	60	4.9
158	70	3.4
176	80	2.4
194	90	1.8
212	100	1.3
248	120	0.7
302	150	0.3

TEST #12b: DRY TEMPERATURE SENSOR (NTC)

The ACU monitors the heater channel temperature using the dry NTC, and cycles the dry heater relay on and off to maintain the desired temperature.

NOTE: Begin with an empty washer/dryer at ambient temperature and a clean lint screen.

1. Unplug washer/dryer or disconnect power.
2. Gently lay washer/dryer on its right side to access the ACU. Remove AC shield and ACU cover.
3. Remove connector **J14** from the ACU and measure the resistance between J14-1 and J14-2 at the connector. The following table gives temperatures and their associated resistance values.

THERMISTOR SENSOR RESISTANCE		
Approx. Temperature		Approx. Resistance
F°	C°	(KΩ)
-4	-20	197.3
14	-10	111.6
32	0	65.5
59	15	31.5

- If the resistance is infinite or close to zero, go to step 4.
 - If it is within range, go to step 7.
4. Remove the top panel to access the heater channel assembly.
 5. Disconnect the dry temperature sensor connector from the NTC. See Figure 1.
 6. Using an ohmmeter, measure the resistance across pins 1 and 2 of the dry temperature sensor.
 - If the resistance is within the specified range, the sensor is good; replace the main harness.
 - If the resistance is far out of range or open, replace the temperature sensor.
 7. If the preceding steps did not correct the dry temperature sensor problem, replace the ACU.

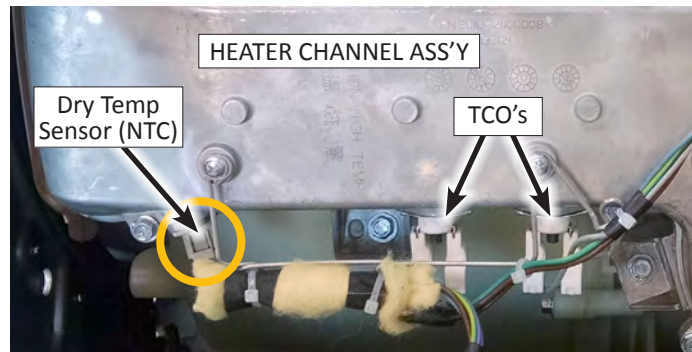

Figure 1 - Dry NTC Location on Heater Channel Assembly

DRY TEMPERATURE SENSOR (NTC)

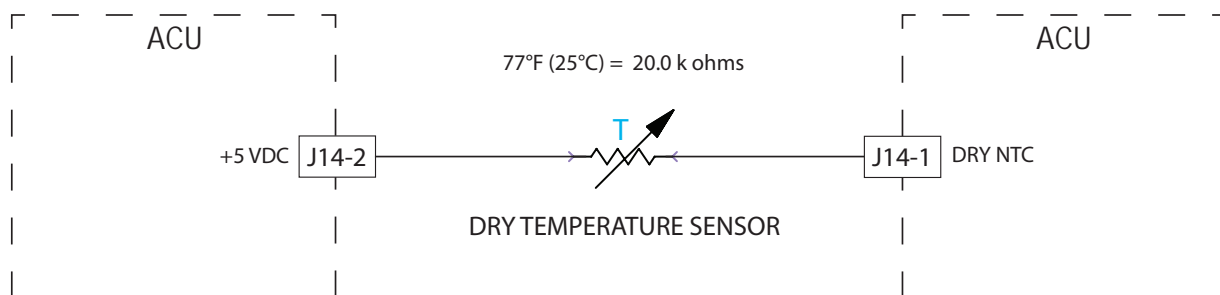



Figure 2 - Dry Temperature Sensor (NTC) Strip Circuit

For Service Technician Use Only

⚠ WARNING



Electrical Shock Hazard

Disconnect power before servicing.

Replace all parts and panels before operating.

Failure to do so can result in death or electrical shock.

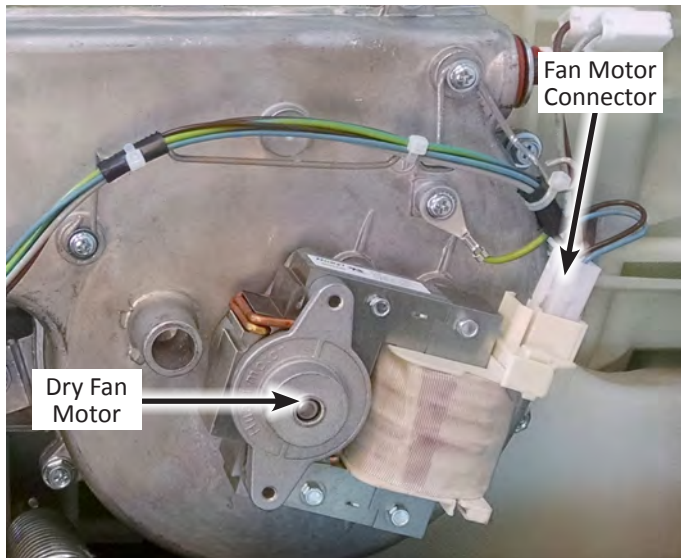

Figure 1 - Dry Fan Motor

TEST #13: Dry Fan Motor

This test checks the dry fan motor and wiring.

1. Check the motor and electrical connections by performing the Service Diagnostic Mode Tests on page 2-3. The following steps assume that this step was unsuccessful.
2. Unplug washer/dryer or disconnect power.
3. Gently lay washer/dryer on its right side to access the ACU. Remove AC shield and ACU cover.
4. Visually check that the **J7** is inserted all the way into the ACU.
 - If visual check passes, go to step 5.
 - If connector is not inserted properly, reconnect **J7** and repeat step 1.
5. Disconnect connector **J7** from the ACU.
6. Using an ohmmeter, measure the resistance across pins 1 and 2 of connector **J7**.
 - If the resistance is **40–50 Ω**, the dry fan motor and wiring are good; go to step 8.
 - If the resistance is open, remove the top panel to access the dry fan motor (see Figure 1). Check continuity of the dry fan motor harness between the ACU and Fan Motor.

7. Disconnect wire connection and measure resistance between contacts of dry fan motor.
 - If resistance is **40–50 Ω**, go to step 9.
 - If the resistance is much less or much greater than 40-50 Ω, replace the Heater Channel Assembly.

NOTE: The dry fan motor cannot be replaced separately from the Heater Channel Assembly.
8. Remove the Heater Channel Assembly.
9. Confirm that the blower wheel is not obstructed and turns freely.
 - If the blower wheel is obstructed, remove debris and re-assemble to washer/dryer.
 - If the blower wheel is not obstructed but does not turn freely, replace the Heater Channel Assembly.

NOTE: The dry fan motor cannot be replaced separately from the Heater Channel Assembly.
 - If the blower wheel turns freely, replace the ACU.
10. Perform the Service Diagnostic Mode Tests on page 2-3 to verify repair.

DRY FAN MOTOR

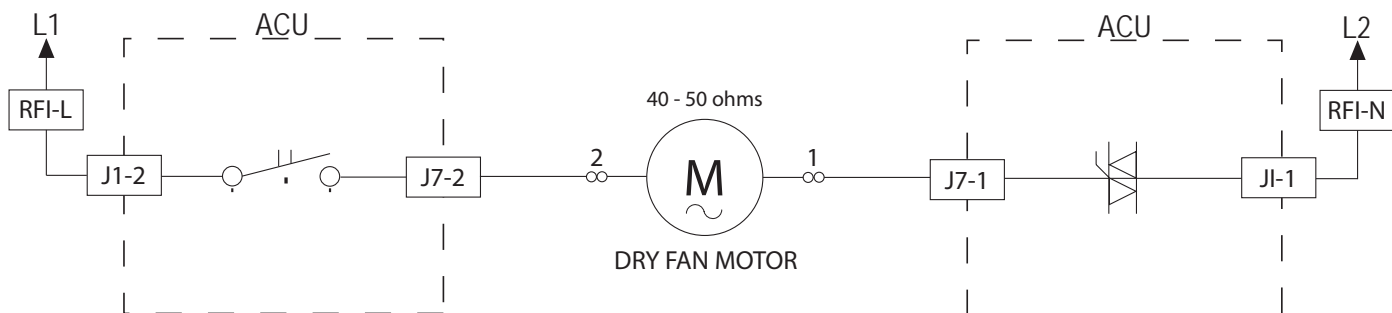

Figure 2 - Dry Fan Motor Strip Circuit

Notes

Section 4: Component Access

This section provides service parts, assemblies, and component locations for the “Whirlpool Smart All-In-One Washer & Dryer.”

- Removing the Door Assembly
- Removing the Top Panel
- Replacing the Human Machine Interface (HMI)
- Removing the Front Panel and Bulkhead
- Removing the Rear Access Panel
- Removing the Inlet Valve Assembly
- Removing the Pressure Switch
- Removing the Metering Pumps
- Removing the Detergent Dispenser
- Removing the Dryer Channel Assembly
- Removing the Condenser Duct Assembly
- Removing the RFI Filter
- Removing the Door Lock Assembly
- Removing the Appliance Control Unit (ACU)
- Removing the Motor Control Unit (MCU)
- Removing the Heater & Thermistor
- Removing the Drain & Recirculation Pump
- Removing the Direct Drive Motor
- Removing the Tub Assembly

Removing the Door Assembly

⚠ WARNING



Electrical Shock Hazard

Disconnect power before servicing.

Replace all parts and panels before operating.

Failure to do so can result in death or electrical shock.



Figure 2

To Remove the Door Assembly

1. Unplug washer or disconnect power.
2. Open door and remove the two (2) hinge screw covers illustrated in Figure 1.



Figure 1

3. Using a Phillips screwdriver, remove the two door hinge cover screws. Remove door hinge cover and set aside.
4. Pull out the HMI connector bag from below door hinge (see Figure 2 & 3). (The bag is "tucked-away" between the hinge and front panel.) Remove tape and bag, and disconnect HMI connector. Preserve the tape and bag for reassembly.

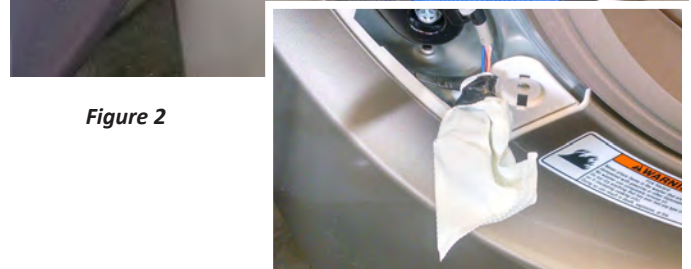

Figure 3 - Connector Bag

5. Remove tape and bag, and disconnect HMI connector (see Figure 4). Preserve the tape and bag for reassembly.

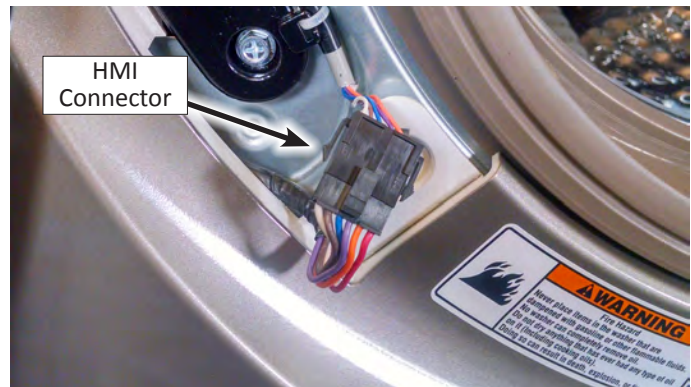



Figure 4

6. Using a 10 mm hex head driver, remove three (3) hinge screws. See Figure 5 at right.
7. Lift up on door assembly and remove.
8. Reverse procedure to reinstall. Be sure to reinstall the HMI connector bag and tape.



Figure 5

Removing the Top Panel

⚠ WARNING

<p style="text-align: center;">Electrical Shock Hazard Disconnect power before servicing. Replace all parts and panels before operating. Failure to do so can result in death or electrical shock.</p>

To Remove the Top Panel

1. Unplug washer or disconnect power.
2. Turn off water supply to washer.
3. Disconnect cold inlet water hose and remove the drain hose from the standpipe or laundry tub.
4. Lift up the bulk detergent lid and remove the bulk dispenser container (see Figures 1 & 2).



Figure 1



Figure 2

5. Next, remove the six screw covers surrounding the dispenser bezel and then remove the (6) Phillips screws (see Figure 3). Remove dispenser bezel.

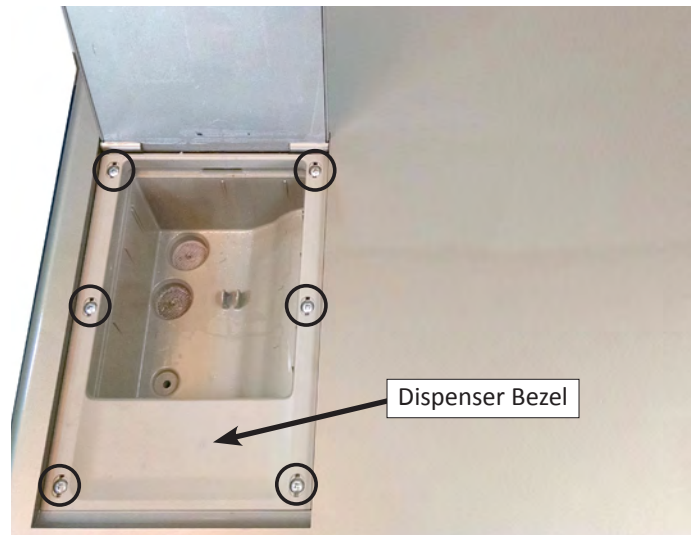

Figure 3

6. Remove two (2) Phillips screws from the rear of the top panel as indicated in Figure 4.

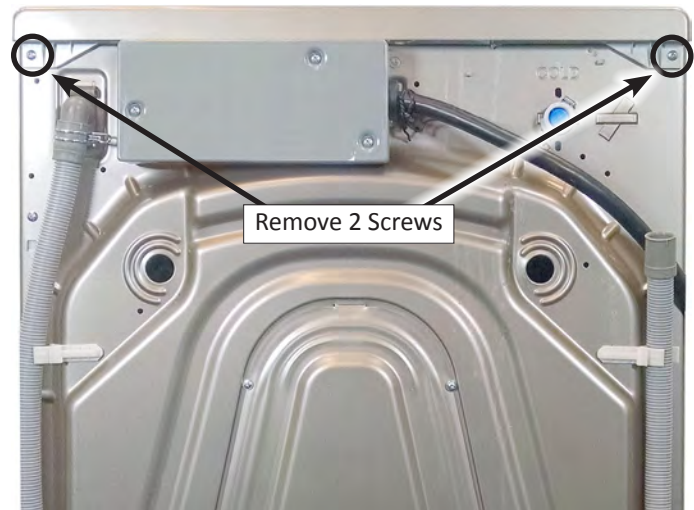



Figure 4

7. From the rear of the washer/dryer, pull back on top cover, lift up and remove.

Replacing the Human-Machine Interface (HMI)

⚠ WARNING



Electrical Shock Hazard

Disconnect power before servicing.

Replace all parts and panels before operating.

Failure to do so can result in death or electrical shock.

1. Unplug washer/dryer or disconnect power.
2. Perform the procedures on page 4-2 “Removing the Door Assembly” prior to performing the following steps.
3. Locate a suitable work surface and lay a soft towel down to protect the door. Place door, front side down, on towel.
4. Using a Phillips screwdriver, remove the five (5) screws indicated in Figure 2. Remove the upper door cover and set aside.

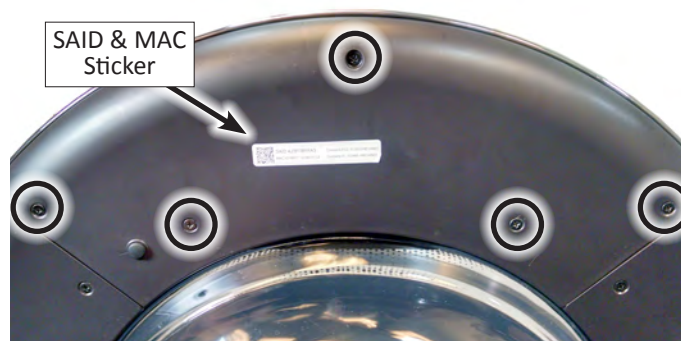

Figure 2 - Upper Door Cover

Replacing the HMI

IMPORTANT:

The WiFi Board is incorporated into the HMI. If the HMI is replaced and the appliance was previously connected to the customer’s Home Area Network (HAN), the washer/dryer must be re-provisioned (reconnected) to the customer’s HAN and added to the customer’s account on the Whirlpool App.

An extra SAID & MAC Sticker is provided with the service replacement HMI. Be sure to place the replacement sticker over the existing sticker on the upper door cover. See Figure 2.

5. Using a Phillips screwdriver, remove the six (6) “lower” inner door screws, the two (2) catch screws, and the three (3) hinge screws indicated in Figure 3. Remove “lower” inner door panel and set aside for reassembly.

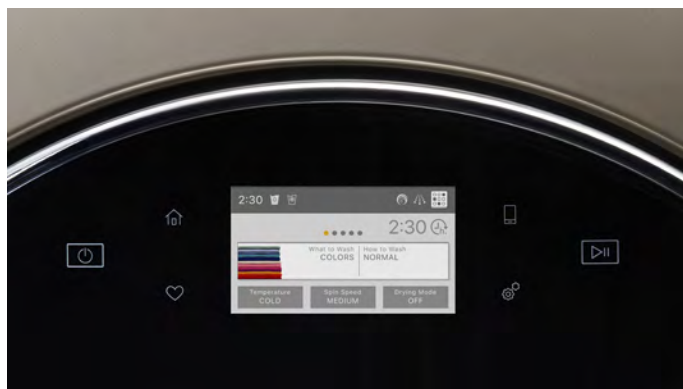

Figure 1 - HMI, Front View

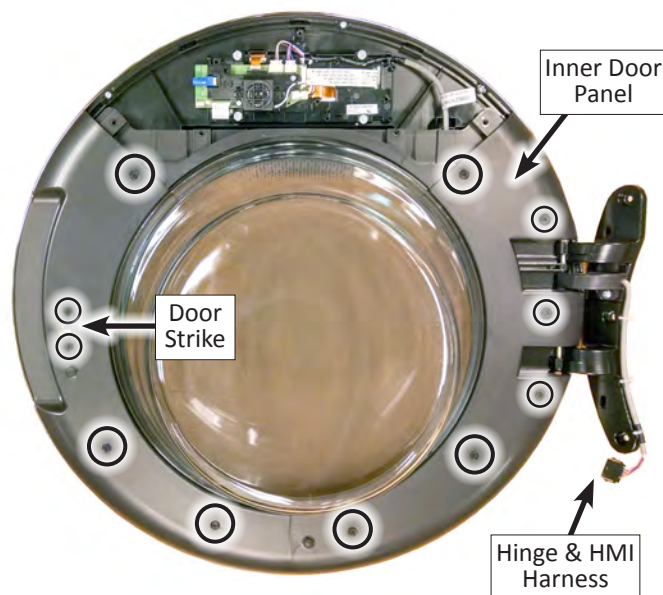

Figure 3

Replacing the Human-Machine Interface (continued)

6. Remove the inner door glass and catch. Set aside for reinstallation to the new Outer Door/HMI Assembly (see Figure 4).

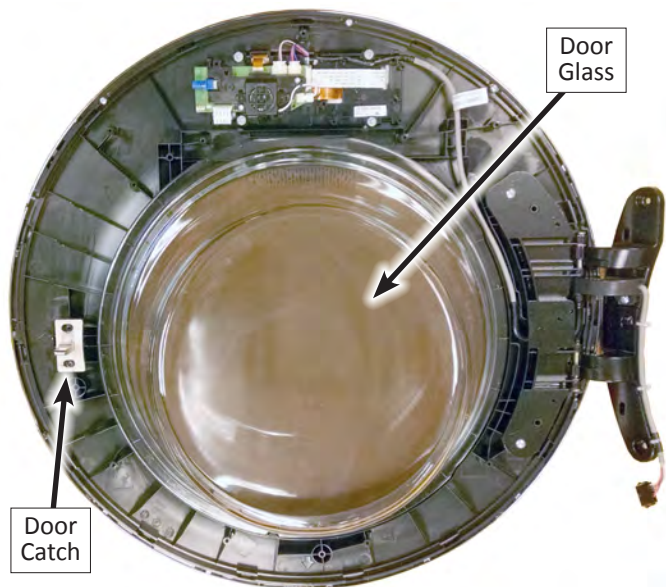

Figure 4

9. Reverse procedure to reassembly all parts onto the new Outer Door/HMI Assembly (see Figure 7).

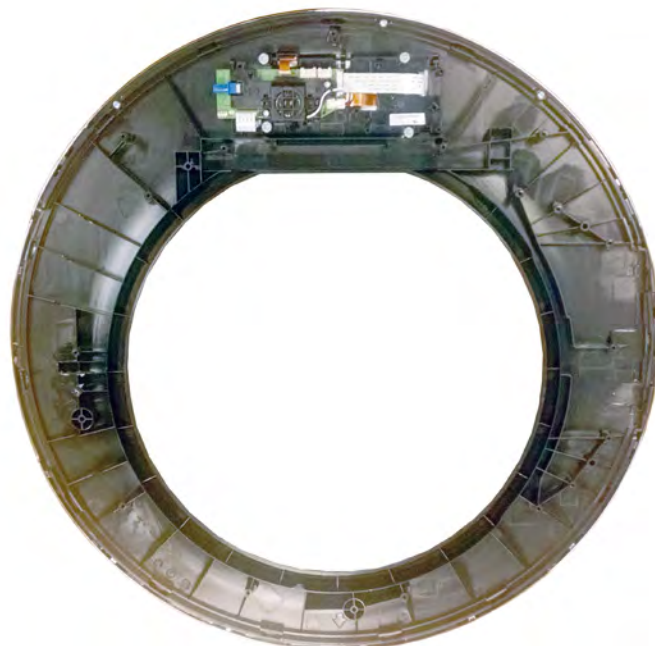

Figure 7 - Outer Door/HMI Assembly

7. Disconnect the ACU and Drum Light harnesses from the HMI. Unclip harness from HMI enclosure. See Figure 5.

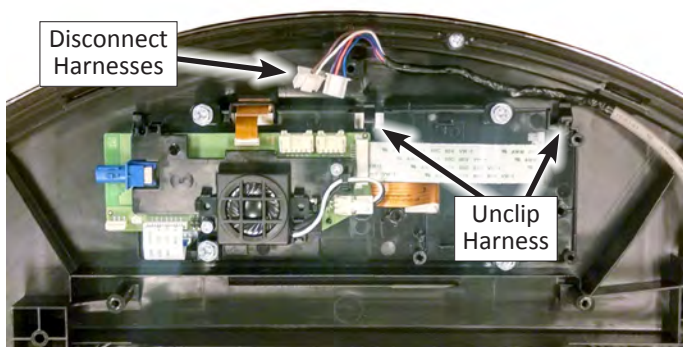

Figure 5

8. Using a Phillips screwdriver, remove the two (2) screws securing the hinge to the outer door/HMI assembly. Remove hinge and harness assembly and set aside for reassembly. See Figure 6.

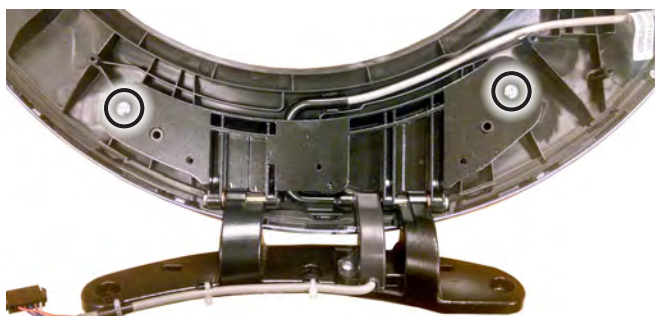
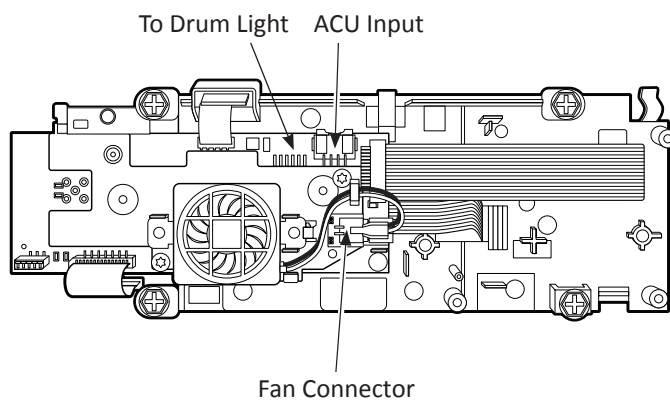

Figure 6

HMI Board



Removing the Front Panel & Bulkhead

⚠ WARNING



Electrical Shock Hazard
Disconnect power before servicing.
Replace all parts and panels before operating.
Failure to do so can result in death or electrical shock.

To Remove the Front Panel

1. Unplug washer/dryer or disconnect power.
2. Turn off water supply to washer/dryer.
3. Disconnect cold inlet water hose and remove the drain hose from the standpipe or laundry tub.
4. Perform the procedures on page 4-2 "Removing the Door Assembly" prior to performing the following steps.
5. Perform the procedures on page 4-3, "Removing the Top Panel" prior to performing the following steps.
6. Open the drain access door at the bottom of the front panel. Unclip the drain hose from its 3 clips. Remove the Phillips screw securing the manual door release tab.

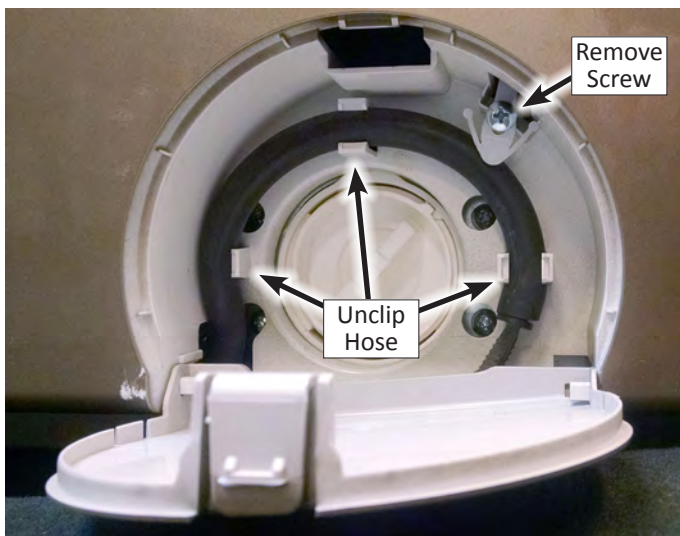

Figure 1

7. Using a Phillips screwdriver, remove the eleven (11) remaining screws indicated in Figure 1.



Figure 2

8. Lift up on the top 4 tabs at the top of the front panel. Separate the front panel slightly from the washer/dryer, while feeding the drain hose and manual door release tab through the panel assembly.
9. Remove front panel from washer/dryer. Set aside for reassembly.
10. Reverse procedure to reinstall front panel.

To Remove the Front Bulkhead

1. Perform the procedures "Removing the Front Panel" prior to performing the following steps.
2. Remove the spring clamp securing the outer bellows to the front bulkhead. Loosen and pull away the bellows from the opening in the bulkhead.
3. Reach in between bellows and front bulkhead to disconnect the door lock harness. Detach door lock harness from bulkhead.
4. Detach the HMI harness from the bottom of the bulkhead.
5. Use a Phillips screwdriver to remove 6 (six) screws, 3 on each side, securing the front bulkhead to the side panels. Lift up on bulkhead to release from side panels. Remove bulkhead and set aside for reassembly.
6. Reverse procedure to reinstall bulkhead and front panel.

Removing the Rear Access Panel

⚠ WARNING



Electrical Shock Hazard
Disconnect power before servicing.
Replace all parts and panels before operating.
Failure to do so can result in death or electrical shock.

To Remove the Rear Access Panel

1. Unplug washer or disconnect power.
2. Turn off water supply to washer.
3. Disconnect cold inlet water hose and remove the drain hose from the standpipe or laundry tub.
4. Remove six (6) Phillips screws securing the rear access panel to the back panel as indicated in Figure 1. Remove rear access panel.



Figure 1

Removing the Inlet Valve Assembly

⚠ WARNING



Electrical Shock Hazard

Disconnect power before servicing.

Replace all parts and panels before operating.

Failure to do so can result in death or electrical shock.

To Remove the Inlet Valve Assembly

1. Unplug washer/dryer or disconnect power.
2. Turn off water supply to washer/dryer.
3. Disconnect cold inlet water hose and remove the drain hose from the standpipe or laundry tub.
4. Perform the procedures on page 4-3, "Removing the Top Panel" prior to performing the following steps.
5. Disconnect the inlet valve connector (see Figure 1).

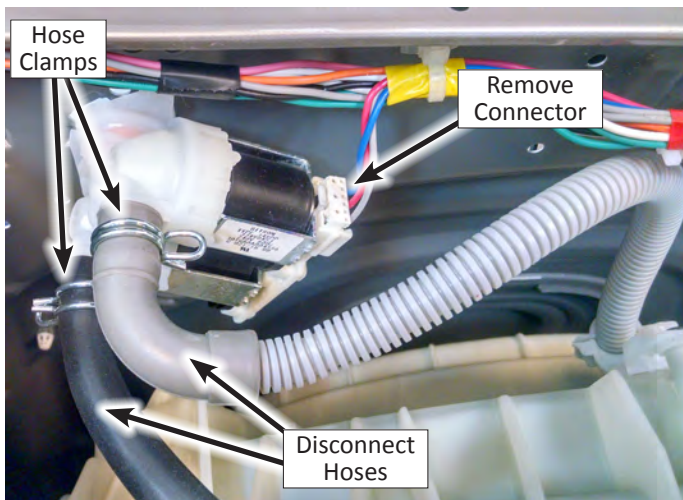

Figure 1

6. Rotate the valve 90 to disengage from rear panel.
7. Slide the two (2) inlet valve clamps away from the valve assembly and remove the two hoses (see Figure 1).

Inlet Hose Connections

The inlet hoses must be connected properly. The gray hose (to condenser sprayer) connects to the top valve port and the black hose (to dispenser) connects to the bottom valve port.

Removing the Pressure Switch

⚠ WARNING



Electrical Shock Hazard
 Disconnect power before servicing.
 Replace all parts and panels before operating.
 Failure to do so can result in death or electrical shock.

To Remove the Pressure Switch

1. Unplug washer/dryer or disconnect power.
2. Turn off water supply to washer/dryer.
3. Disconnect cold inlet water hose and remove the drain hose from the standpipe or laundry tub.
4. Perform the procedures on page 4-3, "Removing the Top Panel" prior to performing the following steps.
5. The pressure switch is located on the right panel toward the front.
6. Squeeze the pressure switch mounting clip to remove the pressure switch from the side panel (see Figure 1).

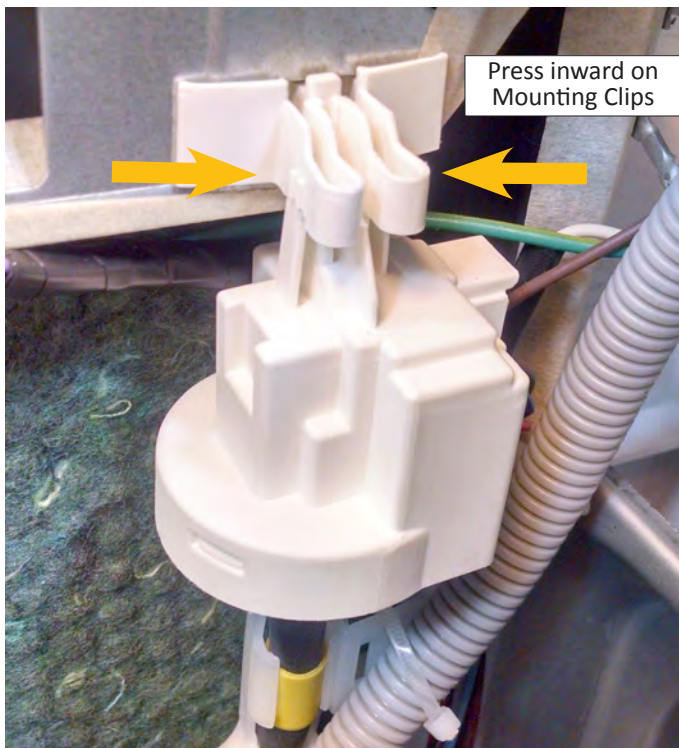

Figure 1

7. Remove the hose from the pressure switch (see Figure 2).
8. Disconnect the pressure switch harness (see Figure 2.) Press the clip away from the harness and slide out connector.

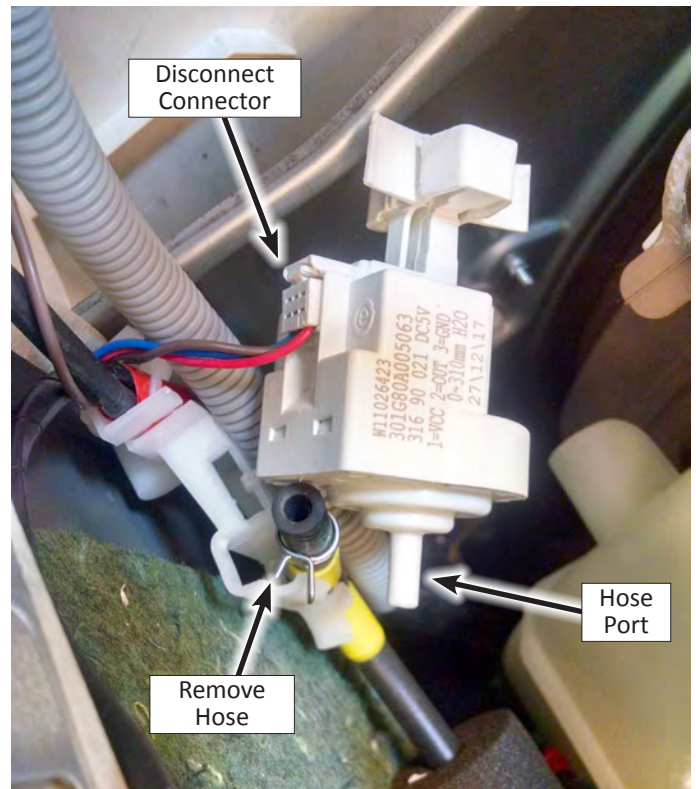



Figure 2

9. Reverse procedure to reinstall pressure switch.

Removing the Metering Pumps

⚠ WARNING



Electrical Shock Hazard

Disconnect power before servicing.

Replace all parts and panels before operating.

Failure to do so can result in death or electrical shock.

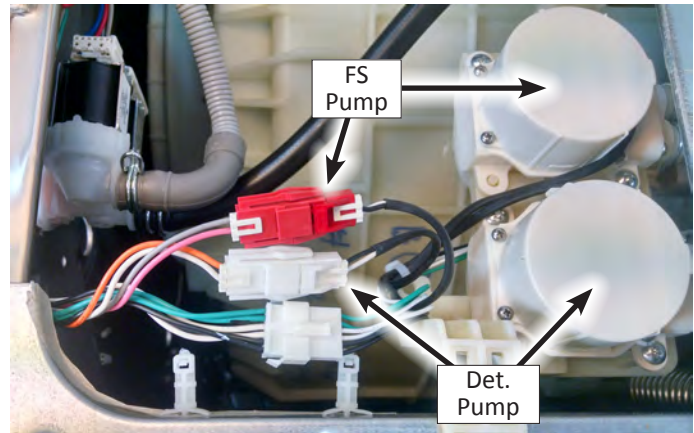

Figure 2

To Remove the Metering Pumps

1. Unplug washer/dryer or disconnect power.
2. Turn off water supply to washer/dryer.
3. Disconnect cold inlet water hose and remove the drain hose from the standpipe or laundry tub.
4. Perform the procedures on page 4-3, "Removing the Top Panel" prior to performing the following steps.
5. For ease of pump removal, take out the "T" shaped cross-brackets by removing eight (10) Phillips screws.
 - NOTE:** Eight screws secure the "T" bracket to the cabinet and 2 to the dispenser.
6. The two (2) metering pumps are located behind the bulk detergent dispenser (see Figure 1). Clip the three wire ties securing the metering pump harnesses. Gently remove the tape and connector coverings for reinstallation later.

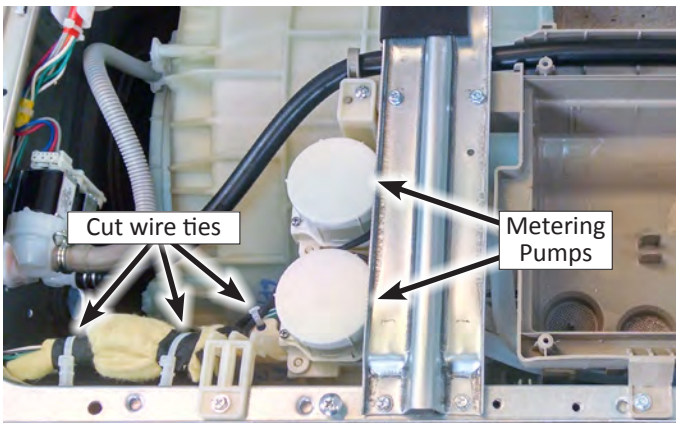

Figure 1

7. **NOTE:** The Detergent and Fabric Softener metering pumps have different part numbers. For ease in replacement and diagnostics, the Fabric Softener pump has a "red" connector and the Detergent pump has a "white" connector (see Figure 2).

8. Remove the two (2) Phillips screws securing the metering pump to the dispenser assembly (see Figure 3).

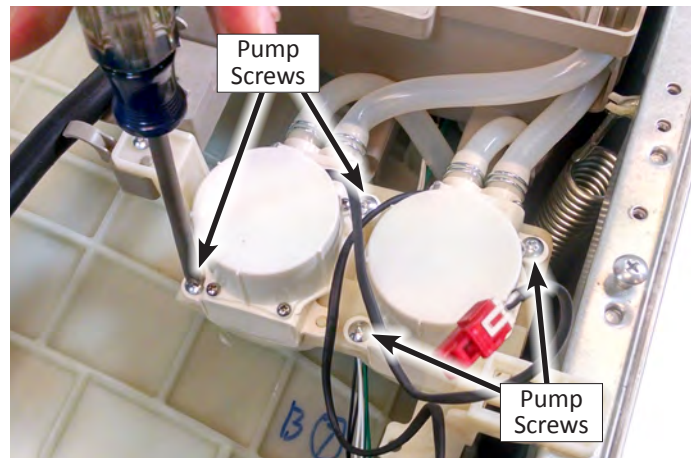

Figure 3

9. Lift up the metering pump to access the clamps and hoses. Disconnect hoses and remove pump (see Figure 4).

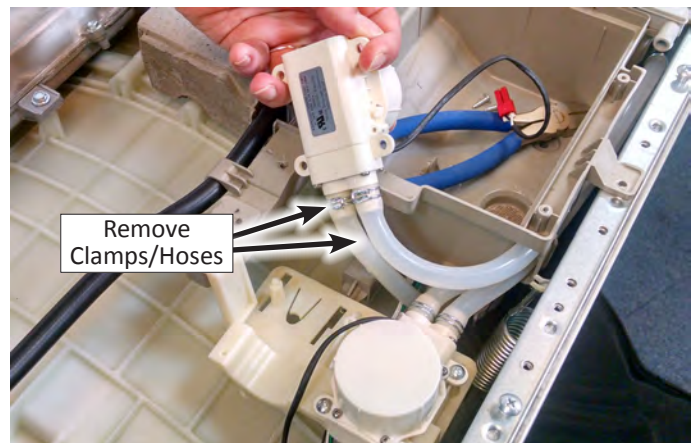



Figure 4

10. Reverse procedure to reinstall metering pump. Be sure to reinstall the connector wrappings, tape and wire ties.

Removing the Detergent Dispenser

⚠ WARNING



Electrical Shock Hazard

Disconnect power before servicing.

Replace all parts and panels before operating.

Failure to do so can result in death or electrical shock.

10. Lift up the dispenser assembly. From the front left of the washer/dryer, remove the large “dispenser to tub” hose. See Figure 2.
11. Next remove the medium tub hose (medium front hose to tub). See Figure 2.

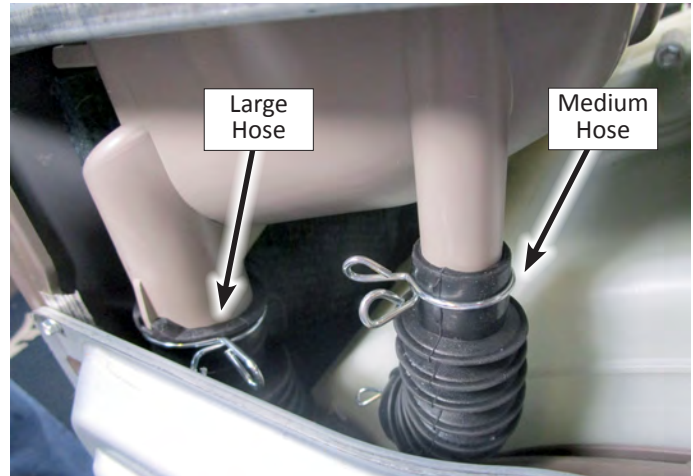

Figure 2

To Remove the Detergent Dispenser

1. Unplug washer/dryer or disconnect power.
2. Turn off water supply to washer/dryer.
3. Disconnect cold inlet water hose and remove the drain hose from the standpipe or laundry tub.
4. Perform the procedures on page 4-3, “Removing the Top Panel” prior to performing the following steps.
5. Perform the procedures on page 4-6, “Removing the Front Panel” prior to performing the following steps.
6. Perform procedure “6” on page 4-10, “Removing the Metering Pumps” prior to performing the following steps.
7. For ease of dispenser removal, take out the “T” shaped cross-brackets by removing eight (10) Phillips screws. **NOTE:** Eight screws secure the “T” bracket to the cabinet and 2 to the dispenser.
8. Remove the remaining 4 screws, illustrated in Figure 1, securing the dispenser to the washer/dryer.
9. Disconnect the black (dispenser) hose from the inlet valve. See Figure 1.

12. Lift dispenser assembly and remove from washer/dryer.
13. Reverse procedure to reinstall dispenser.

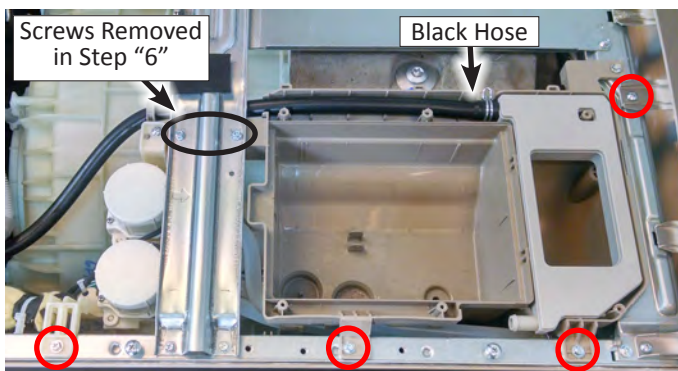

Figure 1

Removing the Dryer Heating Channel Assembly

⚠ WARNING



Electrical Shock Hazard
Disconnect power before servicing.
Replace all parts and panels before operating.
Failure to do so can result in death or electrical shock.

NOTE: If replacing the thermal cutoff, be sure to apply thermal grease/paste to the TCO before reinstalling.

7. Loosen and/or remove the five (5) Phillips screws securing the harness brackets and ground wire to the heater channel as illustrated with circles in Figure 1.
8. Use an 8 mm hex-head driver or ratchet to remove the six (6) screws securing the dryer channel assembly to the drum as illustrated with arrows in Figure 1.
9. From underneath the dryer channel, below the fan motor, loosen the Phillip clamp screw used to secure the dryer channel to the condensate duct. See Figure 2.
10. Gently, lift the “fan” end of the dryer channel assembly away from condenser duct. From underneath the dryer channel, cut the tie strap securing the dryer channel to the bellows (see Figure 3). Remove the dryer channel assembly from the bellows.

To Remove the Dryer Heating Channel Assembly

1. Unplug washer or disconnect power.
2. Turn off water supply to washer.
3. Disconnect cold inlet water hose and remove the drain hose from the standpipe or laundry tub.
4. Perform the procedures on page 4-3, “Removing the Top Panel” prior to performing the following steps.
5. For ease of removal, take out the “T” shaped” cross-brackets by removing eight (10) Phillips screws. **NOTE:** Eight screws secure the “T” bracket to the cabinet and 2 to the dispenser.
6. Disconnect harnesses from the dryer heater, fan motor, two (2) resettable thermal cutoffs, and thermistor (see Figure 1).

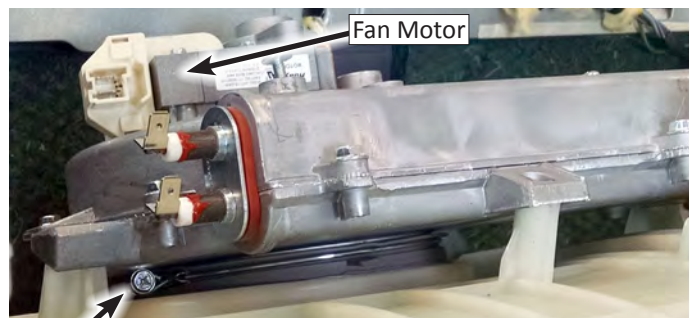

Figure 2 - Clamp Screw



Figure 3 - Lift heat channel to cut strap

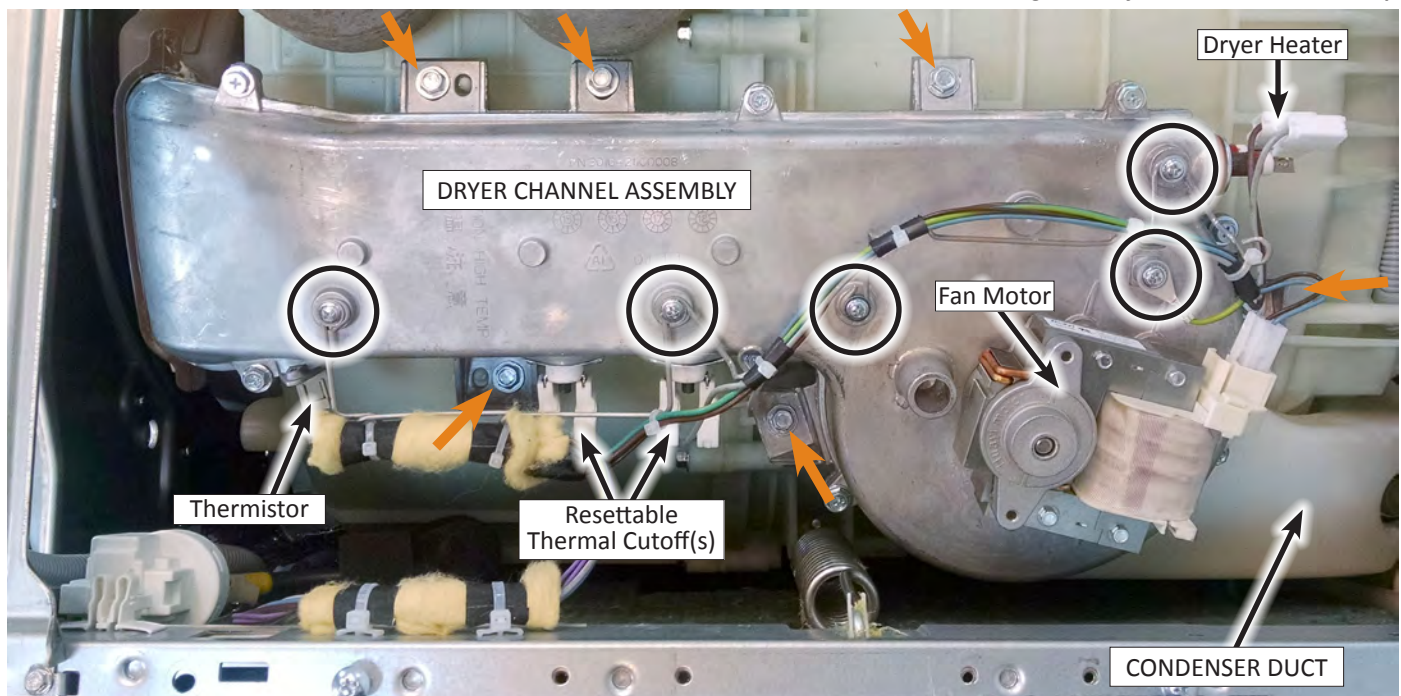

Figure 1 - Dryer Channel Assembly

Removing the Condenser Duct Assembly

⚠ WARNING



Electrical Shock Hazard
 Disconnect power before servicing.
 Replace all parts and panels before operating.
 Failure to do so can result in death or electrical shock.

To Remove the Condenser Duct Assembly

1. Unplug washer or disconnect power.
2. Turn off water supply to washer.
3. Disconnect cold inlet water hose and remove the drain hose from the standpipe or laundry tub.
4. Perform the procedures on page 4-3, "Removing the Top Panel" prior to performing the following steps.
5. Perform the procedures on page 4-7, "Removing the Rear Access Panel" prior to performing the following steps.
6. Perform the procedures on page 4-12, "Removing the Dryer Heater Channel Assembly" prior to performing the following steps.
7. At this point, the Condenser Duct Assembly should look like the example in Figure 1 below.

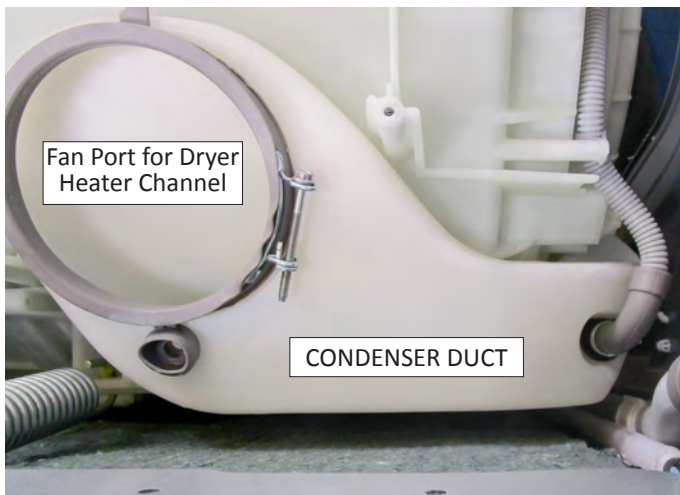

Figure 1

8. Use needle nose pliers to remove the clamp and hose from the cooling nozzle on the top of the condenser duct. See Figure 2.

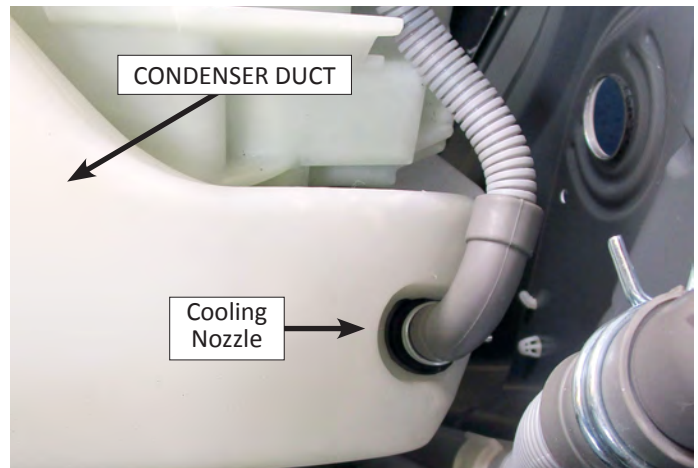

Figure 2

9. Gently lay washer/dryer on its right side to access the lower part of the condenser duct that connects to the rear lower drum.
10. Locate the clamp screw at the bottom of the condenser duct. Loosen the clamp screw and separate the lower condensate duct from the drum (see Figure 3).

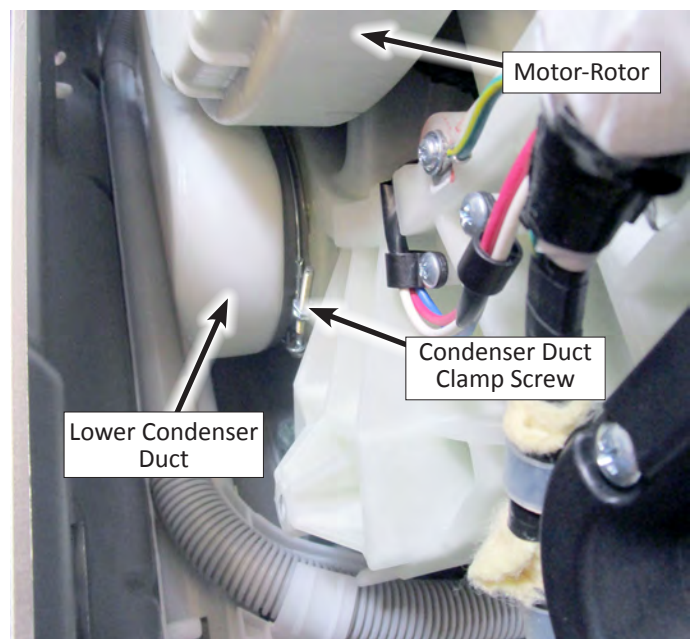



Figure 3

11. Remove condenser duct assembly from washer/dryer. If necessary, remove cooling valve from condenser duct.
12. Reverse procedure to reinstall condenser duct.

Removing the RFI Filter

⚠ WARNING



Electrical Shock Hazard
Disconnect power before servicing.
Replace all parts and panels before operating.
Failure to do so can result in death or electrical shock.

To Remove the RFI Filter

1. Unplug washer or disconnect power.
2. Turn off water supply to washer.
3. Disconnect cold inlet water hose and remove the drain hose from the standpipe or laundry tub.
4. Perform the procedures on page 4-3, "Removing the Top Panel" prior to performing the following steps.
5. Using a Phillips screwdriver, remove the three (3) screws indicated in Figure 1. Remove terminal box cover.

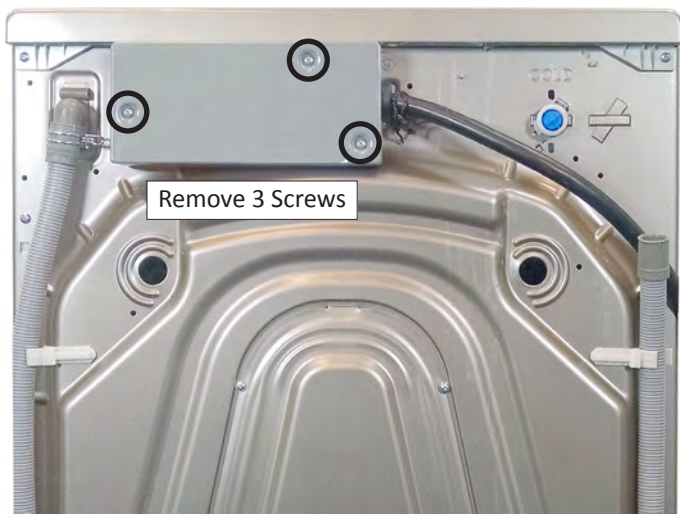

Figure 1

6. Inside the terminal box, remove the four (4) Phillips screws securing the terminal box to the rear panel (circled in Figure 2).

7. If a 4-Wire power cord is connected, use an 8 mm driver to remove the grounding screw and ground wire (see Figure 2). Gently, pull the terminal box away from the rear panel.



Figure 2

8. Remove the Phillip screw and slide the RFI Filter to the left to disengage from rear panel (see Figure 3).

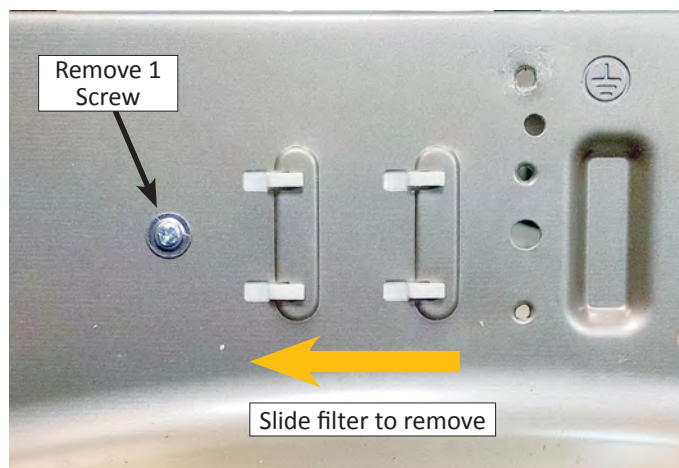

Figure 3

9. Disconnect the RFI's Filter's L1 and L2 terminals, and output connector to ACU (see Figure 4).

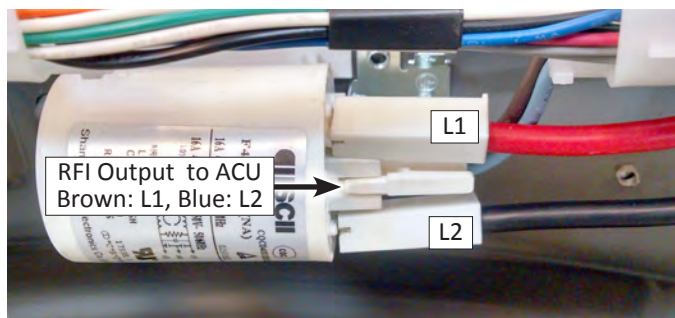

Figure 4

10. Reverse procedure to reinstall the RFI Filter.

Removing the Door Lock Assembly

⚠ WARNING



Electrical Shock Hazard
 Disconnect power before servicing.
 Replace all parts and panels before operating.
 Failure to do so can result in death or electrical shock.

To Remove the Door Lock Assembly

1. Unplug washer/dryer or disconnect power.
2. Turn off water supply to washer/dryer.
3. Disconnect cold inlet water hose and remove the drain hose from the standpipe or laundry tub.
4. Perform the procedures on page 4-2 "Removing the Door Assembly" prior to performing the following steps.
5. Perform the procedures on page 4-3, "Removing the Top Panel" prior to performing the following steps.
6. Perform the procedures on page 4-6 "Removing the Front Panel Assembly" prior to performing the following steps.
7. Remove the spring clamp securing the outer bellows to the front bulkhead. Loosen and pull away the bellows from the opening in the bulkhead.

8. Remove the manual door unlock strap from the lock assembly (see Figure 1).
9. Using a pair of needle nose pliers, depress tabs on clip and push through the bulkhead (see Figure 1).
10. Remove the two (2) Phillips screws securing the lock assembly to the bulkhead (see Figure 1).

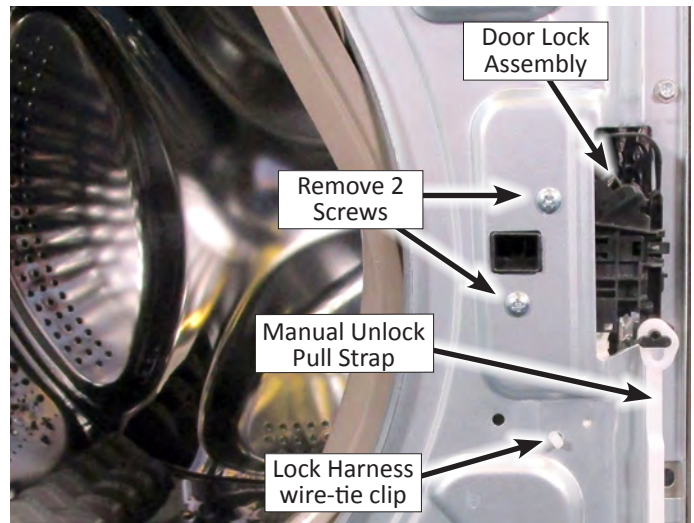



Figure 1

11. Reach in between bellows and front bulkhead and pull the door lock assembly out through the opening. (It may be necessary to disconnect the door lock harness.)
12. Reverse procedure to reinstall the door lock assembly.

Removing the Appliance Control Unit (ACU)

⚠ WARNING



Electrical Shock Hazard

Disconnect power before servicing.

Replace all parts and panels before operating.

Failure to do so can result in death or electrical shock.

To Remove the ACU

1. Unplug washer or disconnect power.
2. Turn off water supply to washer.
3. Disconnect cold inlet water hose and remove the drain hose from the standpipe or laundry tub.
4. Gently lay washer/dryer on its right side to access the ACU.
5. Remove the two (2) screws securing the ACU protection bracket (see Figure 1). Remove bracket and set aside for reassembly.

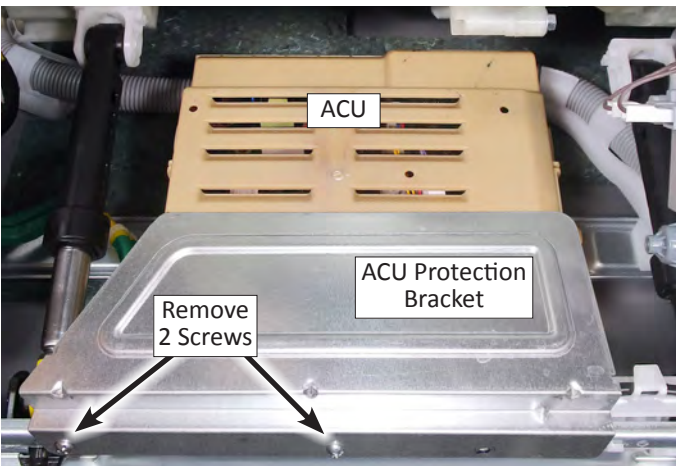

Figure 1

6. Press the two tabs on the cover and slide the ACU cover up to remove (see Figure 2).

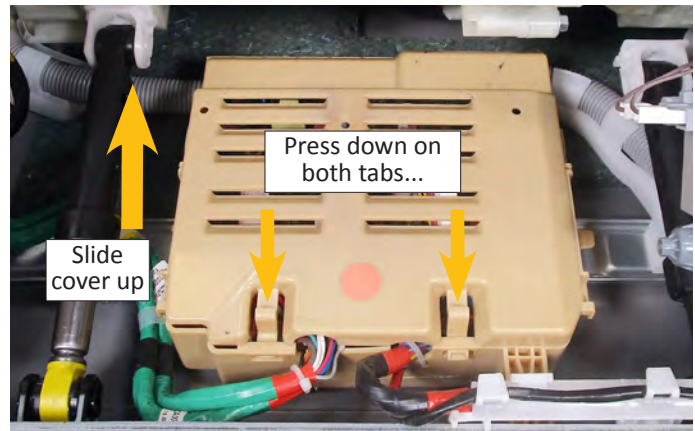

Figure 2

7. Disconnect all harness from the ACU. (All harness connectors are color coded to the board connectors.) See Figure 3. **(See Important Note below-left.)**
8. Lift up on the plastic release lever attached to the ACU. At the same time, slide the ACU to the right and then up to release the ACU tabs from the slots in the washer cabinet. See Figure 3.

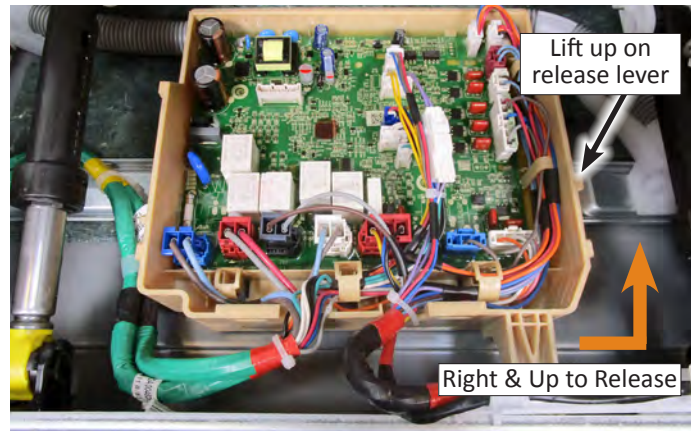

Figure 3

9. With the ACU detached, the control can now be removed from the cabinet. Note the tab slots for reinstallation (see Figure 4).

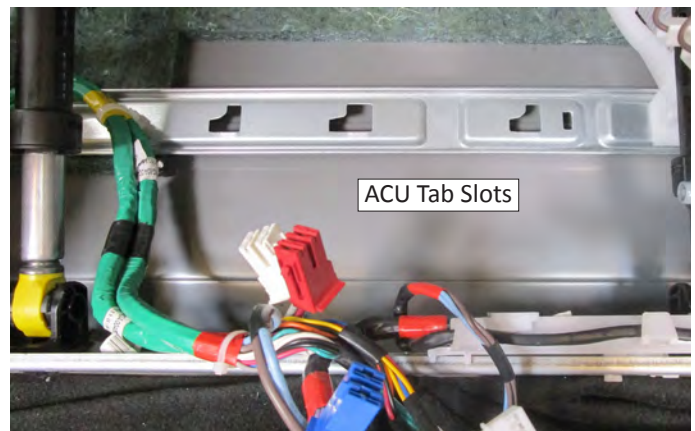



Figure 4

IMPORTANT: Connectors J16 (HMI Comm) and J17 (MCU Comm), are both located next to each other at the top right corner of the ACU and can be mistakenly plugged into each other's connector. If this occurs, it will cause a communication malfunction to both the HMI and Motor Control Unit.

Removing the Motor Control Unit (MCU)

⚠ WARNING



Electrical Shock Hazard
Disconnect power before servicing.
Replace all parts and panels before operating.
Failure to do so can result in death or electrical shock.

To Remove the MCU

1. Unplug washer or disconnect power.
2. Turn off water supply to washer.
3. Disconnect cold inlet water hose and remove the drain hose from the standpipe or laundry tub.
4. Remove six (6) Phillips screws securing the rear access panel to the back panel as indicated in Figure 1. Remove rear access panel.



Figure 1

5. Gently lay washer/dryer on its right side to access the MCU.
6. Using a T-20 Torx driver, remove screw used to secure the MCU to the back panel (See Figure 2).
7. From the rear access opening, unclip and open cover on the MCU housing (see Figure 2). Move cover to one side.

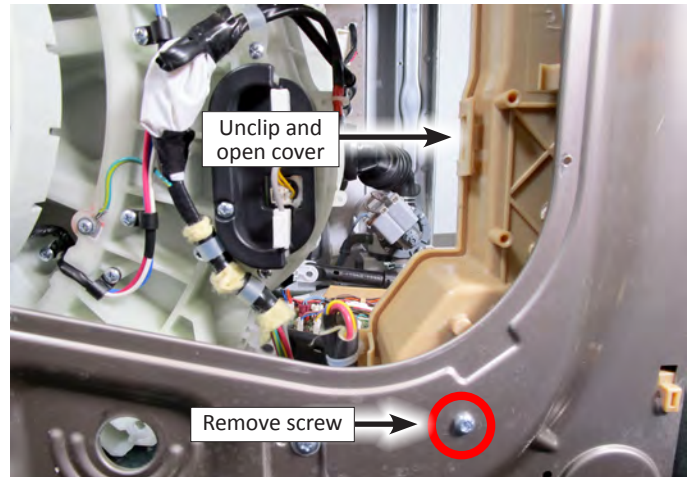

Figure 2

8. Disconnect the connectors indicated in Figure 3.

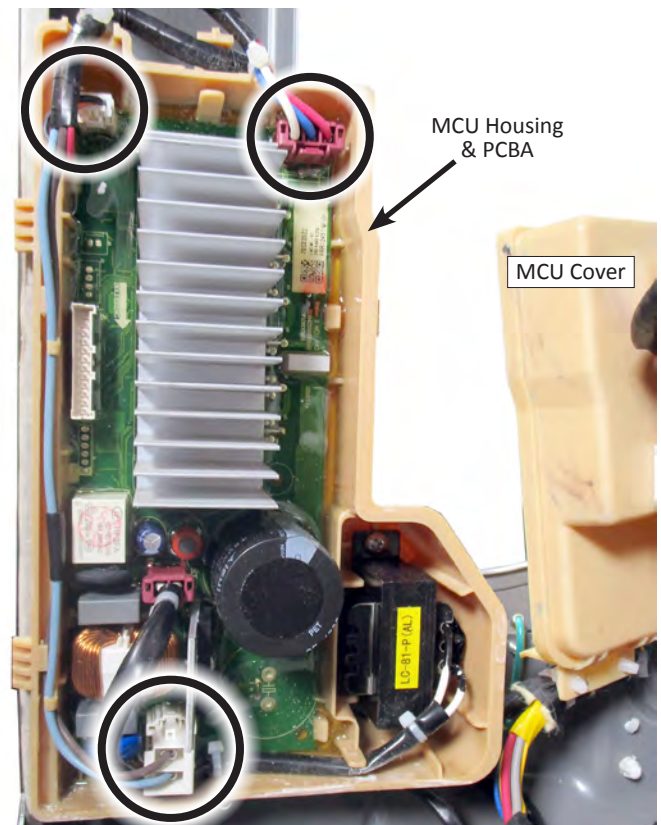

Figure 3

9. Slide the MCU Assembly "up" to disengage from back panel.
10. Reverse procedure to reinstall the MCU.

Removing the Heater & Thermistor

⚠ WARNING



Electrical Shock Hazard
Disconnect power before servicing.
Replace all parts and panels before operating.
Failure to do so can result in death or electrical shock.

To Remove the Heater and Thermistor

1. Unplug washer/dryer or disconnect power.
2. Turn off water supply to washer/dryer.
3. Disconnect cold inlet water hose and remove the drain hose from the standpipe or laundry tub.
4. Remove six (6) Phillips screws securing the rear access panel to the back panel as indicated in Figure 1. Remove rear access panel.



Figure 1

5. Remove all connectors from the heater and temperature thermistor (see Figure 2).
6. Remove the Phillips screw securing the heater cover to the tub (see Figure 2). Remove the heater cover.

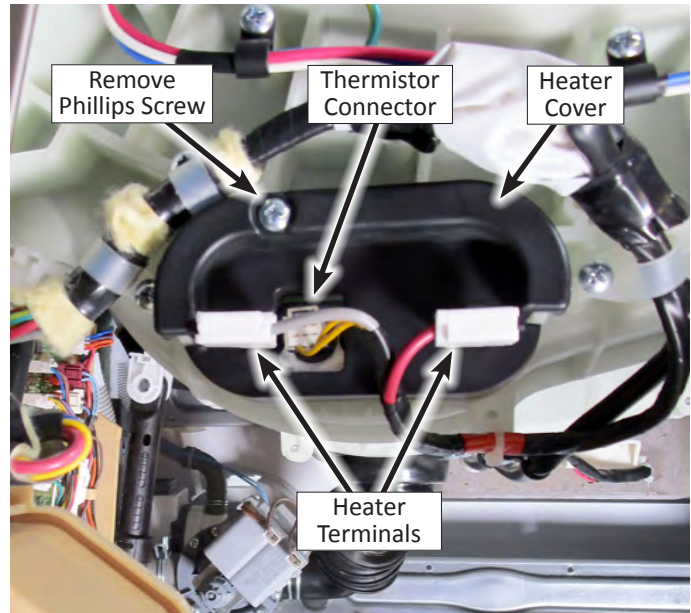

Figure 2

7. Loosen the heater's 10 mm compression nut (to the right of the thermistor), but do not remove it completely.
8. Gently pull the heater assembly from the tub.

Reinstall Notes

1. For reinstallation, make sure the new heater is going to be put underneath the clamp that is fixed on the bottom of the tub.
2. Turn the drum slowly after the new heater has been installed, to make sure the heater is not touching the drum.
3. Run cycle for leak testing.

Removing the Drain & Recirculation Pumps

WARNING



Electrical Shock Hazard
 Disconnect power before servicing.
 Replace all parts and panels before operating.
 Failure to do so can result in death or electrical shock.

7. Disconnect all hose clamps and hoses from the drain and recirculation pumps (see Figure 2).
8. Disconnect the harness from both the drain and recirculation pumps. See Figure 2.

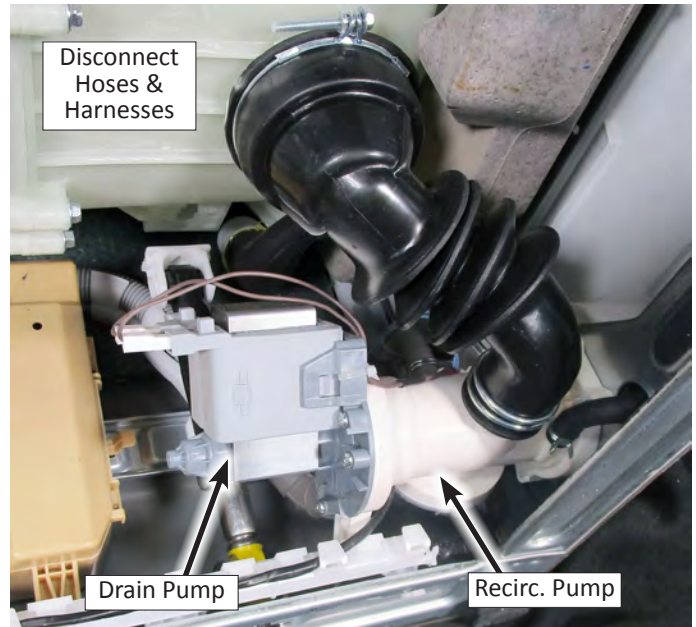

Figure 2

To Remove the Drain Pump & Recirculation Pumps

1. Unplug washer/dryer or disconnect power.
 2. Turn off water supply to washer/dryer.
 3. Disconnect cold inlet water hose and remove the drain hose from the standpipe or laundry tub.
 4. Remove the drain hose from its clips. Open drain hose to drain any water remaining in the drain and recirculation pumps (see Figure 1).
 5. Remove the four (4) Phillips screws securing the drain pump to the front panel. See Figure 1.
- NOTE:** Recommend use of magnetic tipped screwdriver when removing the four screws.

9. Remove pump assembly from washer/dryer. See Figure 3.
10. Reverse procedure to reinstall pumps.

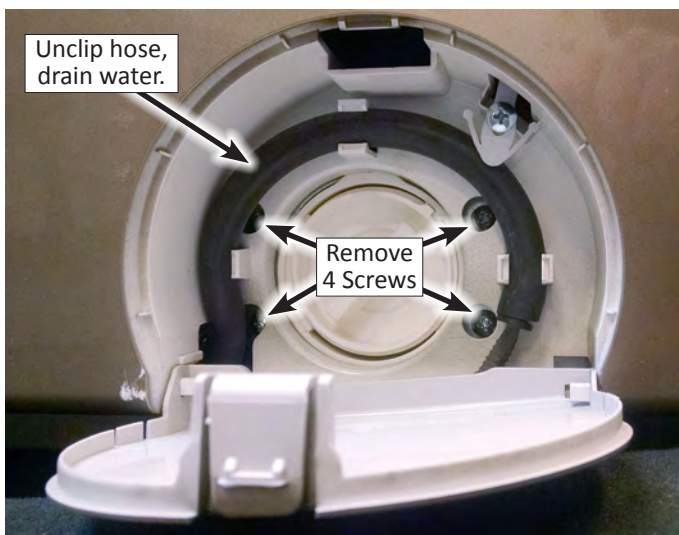

Figure 1

Drain & Recirculation Pumps

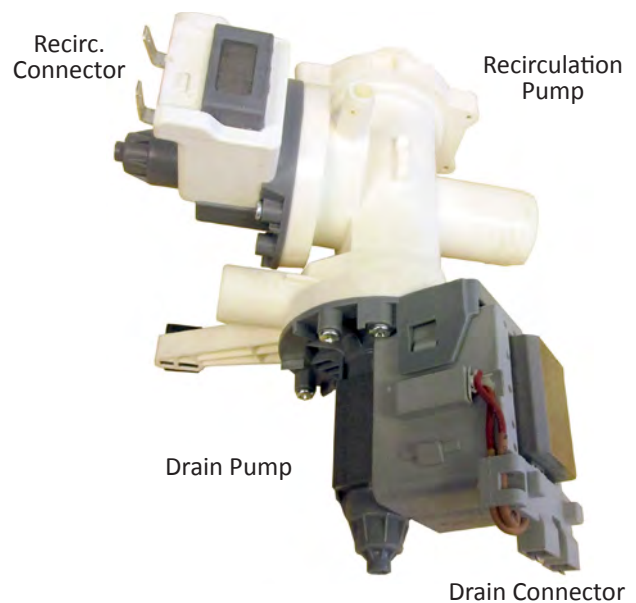

Figure 3

6. Gently lay washer/dryer on its right side to access the Drain and Recirculation Pumps.

Removing the Direct Drive Motor

⚠ WARNING



Electrical Shock Hazard
Disconnect power before servicing.
Replace all parts and panels before operating.
Failure to do so can result in death or electrical shock.

5. Block the rotor by inserting a small 4 mm flat-blade screwdriver into the slot at the back of the rotor as illustrated in Figure 2. Align slot in rotor with receptacle on back of tub (see Figure 2 & 3).



Figure 2 - Lock Rotor Slot

To Remove the Drive Motor

1. Unplug washer/dryer or disconnect power.
2. Turn off water supply to washer/dryer.
3. Disconnect cold inlet water hose and remove the drain hose from the standpipe or laundry tub.
4. Remove six (6) Phillips screws securing the rear access panel to the back panel as indicated in Figure 1. Remove rear access panel.

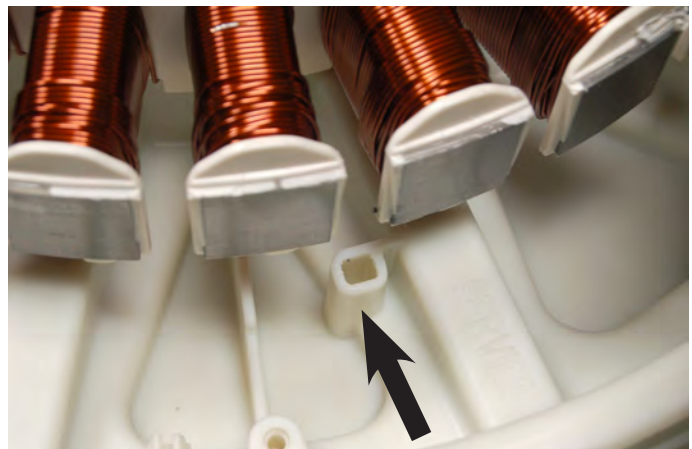

Figure 3 - Lock Rotor Receptacle



Figure 1

Removing the Direct Drive Motor (continued)

6. While the rotor is blocked, use a ratchet and a 5/8" hex head bit to loosen the rotor bolt as shown in Figure 4.

NOTE: The same procedure must be performed when reattaching the rotor during reinstallation.



Figure 4

7. After the rotor screw is removed, push the wash unit towards the front and lock in place with a 2 x 4 or wood block. This allows for room to remove the rotor.
8. Remove the rotor from the stator by pulling it backwards.
9. Unplug the motor connector from the MCU.
10. Use a Phillips screwdriver to remove the six (6) clamp screws securing the motor harness to the back of the tub.
11. Remove any additional harness clips (push mount wire ties) that may be securing the motor harness.
12. Use a T-30 Torx socket to remove the six (6) stator bolts as illustrated in Figure 5. Remove the stator assembly.



Figure 5

IMPORTANT: Be sure to protect the rotor and stator from dust or debris during disassembly and reassembly. Debris on the rotor or stator can damage the motor during operation.

Removing the Tub Assembly

WARNING



Electrical Shock Hazard

Disconnect power before servicing.

Replace all parts and panels before operating.

Failure to do so can result in death or electrical shock.

To Remove the Tub Assembly

1. Unplug washer/dryer or disconnect power.
2. Turn off water supply to washer/dryer.
3. Disconnect cold inlet water hose and remove the drain hose from the standpipe or laundry tub.
4. Perform the procedures on page 4-2, "Removing the Door Assembly" prior to performing the following steps.
5. Perform the procedures on page 4-3, "Removing the Top Panel" prior to performing the following steps.
6. Perform the procedure on page 4-6, "Removing the Front Panel & Bulkhead" prior to performing the following steps.
7. Perform the procedure on page 4-7, "Removing the Rear Access Panel" prior to performing the following steps.
8. Perform the procedures on page 4-8, "Removing the Inlet Valve Assembly" prior to performing the following steps.
9. Perform the procedures on page 4-9, "Removing the Pressure Switch" prior to performing the following steps.
10. Perform the procedures on page 4-11, "Removing the Dispenser Assembly" prior to performing the following steps.
11. Perform the procedures on page 4-12, "Removing the Heater Channel Assembly" prior to performing the following steps.
12. Perform the procedures on page 4-13, "Removing the Condenser Duct Assembly" prior to performing the following steps.
13. Perform the procedures on page 4-14, "Removing the RFI Filter" prior to performing the following steps.
14. Perform the procedures on page 4-18, "Removing the Heater and Thermistor Assembly" prior to performing the following steps.
15. Perform the procedure on page 4-20, "Removing the Direct Drive Motor" prior to performing the following steps.
16. Use a Phillips screwdriver to remove the two (2) screws securing the top-front brace to the side panels. Remove bracket.
17. Use a ratchet and a Torx 50 bit to remove the three (3) screws securing the top counter weight to the top of the tub assembly. Remove counter weight and set aside for reassembly.
18. Use a ratchet and a Torx 50 bit to remove the three (3) screws securing the bottom counter weight to the front of the tub assembly. Remove counter weight and set aside for reassembly.
19. Tip washer/dryer onto its side. Press the tab on one side of the dampers (closest to the tub) and then twist the damper 1/4 turn to disengage from the tub, then pull damper away from tub assembly. Repeat for all dampers.
20. Disconnect drain hose, recirculation hose, and pressure hose from the tub assembly.
21. Remove any harnesses that are secured or wire-tied to the tub assembly.
22. Lift up tub assembly to disengage the right and left suspension springs. Lift and remove tub from the washer/dryer.
23. Reverse procedure to reinstall the tub assembly.

Section 5: Connectivity

This section provides connectivity features, setup, operation, and troubleshooting for the “Whirlpool Smart All-In-One Washer & Dryer.”

- Manually Unlocking the Door Lock System
- Smart Features
- Internet Connectivity Guide
- WPS Connectivity Instructions
- Smart Operation
- Connectivity Troubleshooting

Smart Features

Features

WiFi connectivity allows the Smart Washer/Dryer to connect to the Internet and interact with the Whirlpool™ app from your smartphone or mobile device. This connection opens up several Smart options to you: options intended to save you valuable time and energy.



Smart Features

Smart Features help make your everyday more efficient by letting you remotely monitor, manage, and maintain your washer/dryer.

Remote Start & Pause

What it does: Allows the consumer to send remote control of your washer/dryer to their smartphone or mobile device via the Whirlpool® app.

What it does for the consumer: Lets the consumer manage when to start their wash or dry cycle and when their laundry gets done. Have freshly washed and/or dried laundry when they're ready for it – not just when they're home to wait.

Cycle Progress

What it does: Gives the consumer an up-to-the-minute look at their wash or dry cycle progress and remaining cycle time from anywhere.

What it does for the consumer: Relieves them of having to visit the laundry room to check on the status of their wash or dry cycle.

Clothes Clean Notification (Opt-In)

What it does: Their washer/dryer will send the consumer a push notification when its current cycle is complete.

What it does for the consumer: Alerts the consumer precisely when the laundry is done, so they can get the next load started and move on to other things.

If the consumer can't unload the washer/dryer right away, or are away from home when a cycle finishes, they can remotely activate Tumble Fresh™ or Wrinkle Shield™ cycles to help their clothes stay fresh until they're able to get to them.

Specialty Cycles & My Cycle

What it does: Allows the consumer to browse additional wash cycles available in the Whirlpool® app and download a cycle to the washer with the Download & Go™ option. The consumer can also create and save their own customized cycles.

What it does for the consumer: Takes the guesswork out of selecting the optimal washer settings for garments and household items that require specialized care.

Quiet Mode

What it does: Lets the consumer turn off the tones and beeps coming from their washer.

What it does for the consumer: Allows them to do laundry without disturbing anyone else in the household.

Issue Alerts (Opt-In)

What it does: Sends the consumer a push notification if something has gone wrong.

What it does for the consumer: Gives them a heads-up, and provides guidance to fix simple issues through videos and step-by-step instructions.

If the issue is more complex, the consumer can e-mail or call our service center directly from the Whirlpool® app.

Smart About Energy

The Smart Washer/Dryer can monitor and respond to changing energy demand levels on the power grid.

Smart Delay (Opt-In)

What it does: When energy demand is high, it gives the consumer the option to delay starting a wash or dry cycle until demand levels are lower.

What it does for the consumer: They will feel good about giving a little back to the environment. Some consumers may even see a lower energy bill.

If they need to begin a wash or dry cycle immediately, the consumer can override a Smart Delay. The washer/dryer will return to energy monitoring on the next cycle.

Get Started

Refer to the Quick Connect packet that came with the washer, or see the "Connectivity Setup" section on pages 5-3 and 5-4 of this section and follow the instructions to get connected.

Internet Connectivity Guide

Get the App and Get Connected

With your mobile device, get the app, connectivity setup instructions, terms of use, and privacy policy at:

www.whirlpool.com/connect

In Canada, visit

www.whirlpool.ca/en_CA

and click on the Whirlpool® Connected Appliances link.

IMPORTANT: Proper installation of the appliance prior to use is the customer responsibility. Be sure to read and follow the Installation Instructions that came with the appliance.

Connectivity requires WiFi and account creation. App features and functionality subject to change. Data rates may apply. If you have any problems or questions, call Whirlpool Corporation Connected Appliances at **1-866-333-4591**.

You Will Need:

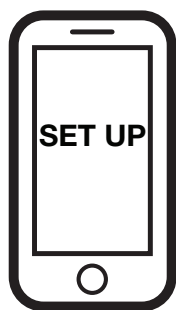

- A home wireless router supporting WiFi, 2.4Ghz with WPA2 security. If you are unsure of the router's capabilities, refer to the router manufacturer's instructions.
- The router to be on and have a live internet connection.
- The 10-character SAID code for the appliance. The SAID code is either printed on a label on the appliance or can be found on the LCD screen. Refer to "General Information" section of this manual for the location.

Perform the following steps to download and install the App. Once installed, launch the app. You will be guided through the steps to set up a user account and to connect the appliance. If you have any problems or questions, call Whirlpool Corporation Connected Appliances at **1-866-333-4591**.

1. Download App

From your mobile device, smartphone, or tablet, go to www.whirlpool.com/connect and follow the instructions to download and install the Whirlpool® app.

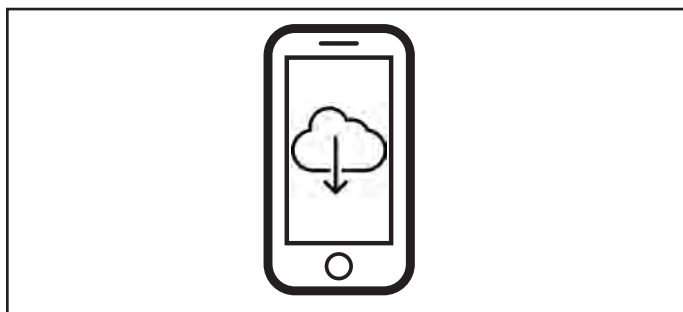

2. Account Setup

Once installed, tap the Whirlpool® app icon to run the app. You will be guided through the steps to set up a user account. The app will make sure to get the necessary personal and home information, as well as information about your energy company.

3. Register the washer/dryer in the user account

Registering the washer/dryer in your account is a necessary step in order for the consumer to take full advantage of the Smart Features. When prompted by the app, enter the Smart Appliance Identification Number (SAID) (case sensitive), which can be found on a sticker inside the washer/dryer door.

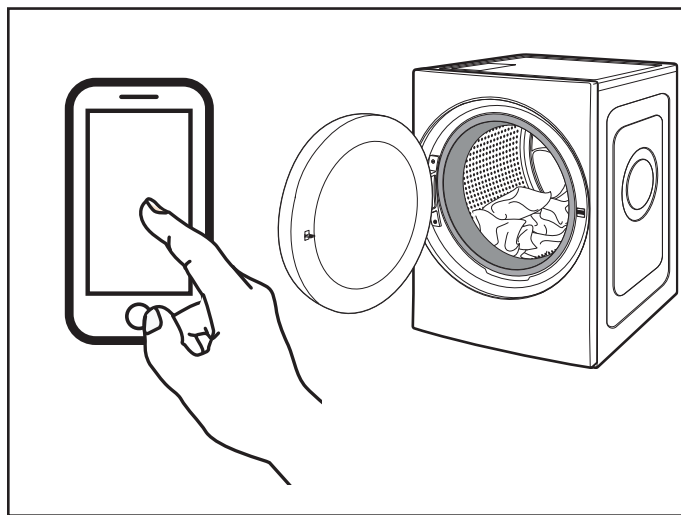

Smart Appliance ID# is:

NOTES:

- Once the washer/dryer is connected to the consumer's home WiFi network, it will remain linked even if the power goes out, the appliance is moved, or if it is put in storage for a while.
- If the consumer replaces their wireless router (or get a different Smart Washer/Dryer), you will need to repeat this connectivity setup process.

WPS Connectivity Instructions

Setup

IMPORTANT: Proper installation of the washer/dryer prior to use is the consumer responsibility. Be sure to read and follow the Installation Instructions that came with the washer/dryer.

Automatic Setup Instructions – WiFi Protected Setup (WPS)

You will need:

- A home wireless router supporting WiFi, 2.4Ghz with WPA2 security. If you are unsure of the router's capabilities, refer to the router manufacturer's instructions.
- The router to be on and have a live internet connection.
- The 10-character SAID code for the appliance. The SAID code is either printed on a label on the appliance or can be found on the LCD screen. Refer to "General Information" section of this manual for the location.

NOTE: If the home wireless router is not equipped with a WPS button, please check the user manual of the router to confirm if it is WPS capable. If not, alternate setup instructions are at www.whirlpool.com/connect.

1. Router Setup

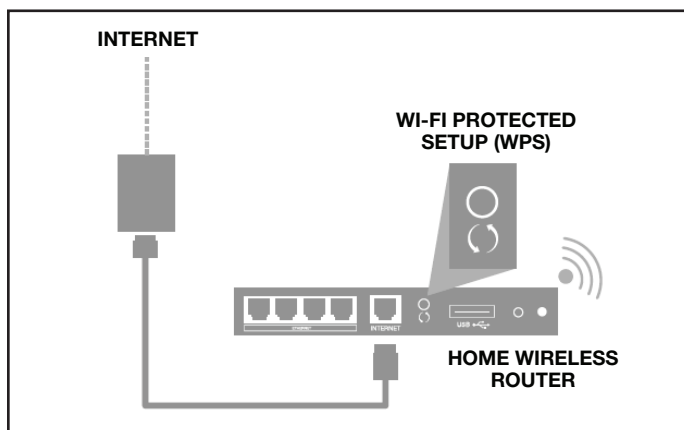

Press the WPS button on the router. An indicator light will begin blinking.

HELPFUL TIP: The WPS function on the router is active for 2 minutes. Complete the next step within that timeframe or you will need to reinitiate WPS.

2. Washer/Dryer setup (time sensitive step)

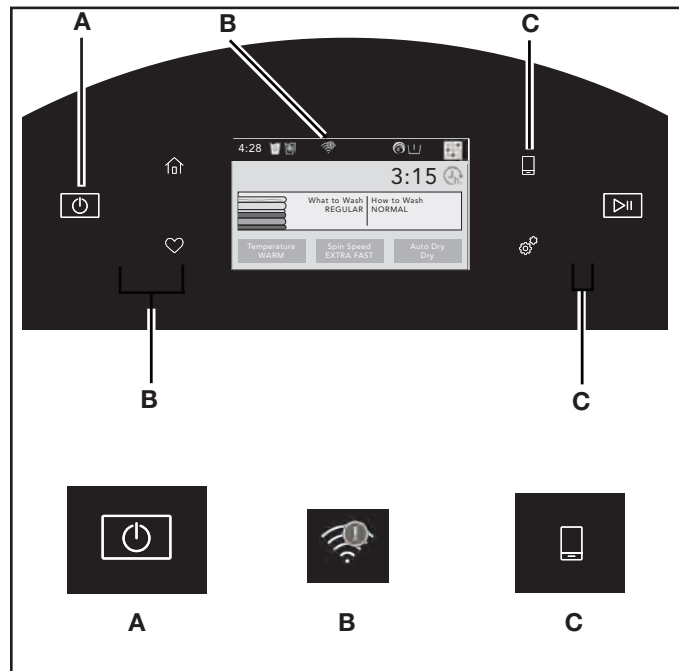

Touch the POWER button (A) to turn on the washer/dryer, then touch the CONNECTED button (C).

The WiFi status indicator (B) on the washer/dryer control panel will blink slowly while the washer and router attempt to connect. The Time/Status display will show a "sensing animation." This can take up to 2 minutes.

If the connection is successful, the WiFi status indicator will come on and remain lit.

If The Washer/Dryer Doesn't Connect

If the washer/dryer and router fail to connect after 2 minutes, the WiFi status indicator (C) will blink rapidly for 2 seconds and then turn off. Refer to the "Troubleshooting Guide" in this section on page 5-6, check any connection instructions for your specific router, and refer to alternate instructions at www.whirlpool.com/connect.

Smart Operation

Smart Operation

NOTE: You must have successfully completed the “Connectivity Setup” section on pages 5-3 and 5-4 for the following features to function. Verify that the WiFi status indicator (📶) is illuminated. Check the Whirlpool® app for additional washer/dryer features, including Delay Start.

Download a Specialty Cycle or My Cycle

The Download & Go™ option lets the consumer select and send a Specialty Cycle or My Cycle from the Whirlpool® app directly to their washer/dryer. The indicator above Download & Go will illuminate. Touch DOWNLOAD & GO to select the cycle. The Time/Status display will show the estimated cycle time. Touch and hold the START/PAUSE button for 3 seconds to start the wash cycle, or continue to set the washer for Remote Start.

HELPFUL TIP: The cycle will be remembered for future use until a different cycle is downloaded to the washer/dryer.

NOTE: If the Download & Go button is touched without a cycle ready for selection (with the indicator not lit), you will hear an “Invalid Keypress” sound (if key activation sounds are turned on).

Set a Remote Start

Remote Start mode allows the consumer to start their washer/dryer remotely from the Whirlpool® app.

After preparing your laundry load and selecting your cycle settings, touch and hold the DOWNLOAD & GO button for 3 seconds. The Remote Start status indicator (🔴) and the indicator above the Start/Pause button will begin blinking. Touch and hold START/PAUSE to set the mode. The indicator above Start/Pause will go out, and the Remote Start indicator will be solidly lit.

When a Remote Start command is received from the app, the washer/dryer will start the cycle, causing the indicator above Start/Pause to be lit (indicating running state). The Remote Start indicator will remain lit.

HELPFUL TIP: Make sure that the washer/dryer remains closed and the cycle is not adjusted until the cycle is started. Any interaction with the washer/dryer itself after a Remote Start has been set will cancel the Remote Start. If the washer/dryer needs to be paused to add garments, the Remote Start will need to be reinitiated.

NOTE: If no WiFi connection is available, the Remote Start will not be set. The WiFi indicator (📶) will blink for 2 seconds, then go out. If the washer/dryer is WiFi connected but the Whirlpool® app service is temporarily unavailable, Remote Start can be set.

IMPORTANT: When using Remote Start to delay a cycle, use only liquid HE detergent in the detergent dispenser and liquid Oxi or liquid color-safe bleach in the TimedOxi dispenser. Powdered detergents and laundry boosters may absorb moisture from a previous cycle and clump before the wash cycle begins.

Connectivity Troubleshooting

Troubleshooting Guide

Connection Status	Control Panel Indicator Lights
Washer/dryer is not connected	<ul style="list-style-type: none"> • WiFi icon is OFF • Smart Grid icons are OFF
Washer/dryer is attempting to connect to home WiFi router	<ul style="list-style-type: none"> • WiFi icon is blinking slowly
Washer/dryer is connected to home WiFi router, but Whirlpool™ app or Smart Grid functions do not work	<ul style="list-style-type: none"> • WiFi icon is ON • Blue Smart Grid icon is blinking slowly
Washer/dryer is connected to home WiFi router, and the Whirlpool™ app works	<ul style="list-style-type: none"> • WiFi icon is ON • Blue Smart Grid icon is either ON or OFF – it is not blinking

If you experience	Possible Causes	Solution
Washer/dryer is not connected to home WiFi router (WiFi icon is OFF)	The washer/dryer may be in standby mode.	Touch the POWER button on the washer and observe indicators. All indicator lights are off when in standby mode.
	The washer/dryer has never been connected to the home WiFi router.	See “Connectivity Guide” in this section, pages 5-3 & 5-4.
	The washer/dryer has been connected to the home WiFi router, but washer/dryer WiFi is OFF.	Press CONNECT. The WiFi icon should blink while connecting (this may take up to 2 minutes).
	Lost connection to home WiFi router.	Check whether the router is on and working with other computers or devices in the home (able to access the Internet).
	Weak signal strength or signal interference between the washer/dryer and router.	Try to place the wireless router closer to the washer/dryer. It may be necessary to install a WiFi range extender.
WiFi icon does not light at all after pressing the Connect button	Something may be wrong with the washer/dryer.	Unplug or disconnect washer/dryer power for 30 seconds. Return power. Repeat WiFi connect process.
		Verify that the washer/dryer operates correctly except for not being able to connect.
Washer/dryer is connected to home WiFi router, but Whirlpool™ app or Smart Grid functions do not work	Smart Grid features on the washer/ dryer may be OFF.	Check whether either Smart Grid indicator is on continuously. Touch CONNECT to turn Smart Grid feature on.
	Connection to the Whirlpool™ app and Smart Grid service may be unavailable.	Check if the blue Smart Grid indicator is blinking.
	User account has not been properly set up, or the washer/dryer has not been registered in an account.	See “Connectivity Guide” in this section or the Whirlpool™ app directly for account setup and washer/dryer registration instructions.
		Verify that the washer/dryer is paired with the customer account in the app. Verify correct e-mail address, mobile number, and notification preferences.

PRODUCT SPECIFICATIONS & WARRANTY INFORMATION SOURCES

IN THE UNITED STATES:

**FOR PRODUCT SPECIFICATIONS AND WARRANTY INFORMATION CALL:
FOR WHIRLPOOL PRODUCTS: 1-800-253-1301**

**FOR TECHNICAL ASSISTANCE WHILE AT THE CUSTOMER'S HOME CALL:
THE TECHNICAL ASSISTANCE LINE: 1-800-832-7174**

**HAVE YOUR STORE NUMBER READY TO IDENTIFY YOU AS AN
AUTHORIZED IN-HOME SERVICE PROFESSIONAL**

**FOR LITERATURE ORDERS (CUSTOMER EXPERIENCE CENTER):
PHONE: 1-800-851-4605**

**FOR TECHNICAL INFORMATION AND SERVICE POINTERS:
www.servicematters.com**

IN CANADA:

**FOR PRODUCT SPECIFICATIONS AND WARRANTY INFORMATION CALL
PHONE: 1-800-461-5681**

**FOR TECHNICAL ASSISTANCE WHILE AT THE CUSTOMER'S HOME CALL:
THE TECHNICAL ASSISTANCE LINE: 1-800-488-4791**

**HAVE YOUR STORE NUMBER READY TO IDENTIFY YOU AS AN
AUTHORIZED IN-HOME SERVICE PROFESSIONAL**

Whirlpool 2.8 CU FT Smart All-In-One Washer & Dryer

W11243198